

CappTronic™

Single- and Multichannel Electronic Pipettes

USER GUIDE

Version: 3.3

Copyright:

No part of this user guide may be reproduced or transmitted in any form or by any means, electronic or mechanical, for any purpose, without prior written permission of AHN Biotechnologie GmbH.

CappTronic™ and Capp™ are trademarks of AHN Biotechnologie GmbH.

Table of Contents

1.	Safety Precautions	1
1.1.	Operation Safety Precautions.....	1
1.2.	Battery Safety	1
2.	General Description	3
3.	Getting Started	4
3.1.	Unpacking.....	4
3.2.	Inserting the Battery	5
3.3.	Charging the Battery.....	5
3.4.	Start Pipetting	7
3.5.	Hanger Installation.....	8
4.	Overview	9
4.1.	Keypad Function.....	10
4.2.	Acoustic Signals	11
5.	Function Map	12
6.	SYS (System) Mode.....	13
6.1.	Aspirating Speed.....	13
6.2.	Dispensing Speed	14
6.3.	Acoustic Signals	14
6.4.	Blow-out	14
6.5.	Reverse Pipetting	15
6.6.	Setting PROG (Programs)	15
7.	AUTO Mode	17
8.	MD (Multiple Dispensing) Mode.....	18
9.	MIX Mode.....	19

- 10. SE (Sequential Aspirating/Dispensing) Mode20**
 - 10.1. SA (Sequential Aspirating) Mode.....20
 - 10.2. SD (Sequential Dispensing) Mode21
- 11. Sterilization23**
 - 11.1. Disassemble Lower Part23
 - 11.2. Reassemble Lower Part25
- 12. Maintenance.....26**
- 13. Troubleshooting27**
- Appendix A: Technical Specifications29**
- Appendix B : Tip Ejector Height Adjustment29**
- Appendix C: Warranty.....30**

1. Safety Precautions

Congratulations to your new CappTronic™. Before it for the first time, please read this entire operating manual carefully. To guarantee problem free, safe operation of your new pipette, it is essential to observe the following points:

1.1. Operation Safety Precautions



When using infectious, radioactive, toxic and other solutions, which may pose health risks, please observe the safety precautions laid down for such materials.

1. Do not use the pipette in a potentially explosive environment or with potentially explosive chemicals.
2. When using organic solvents or corrosive chemicals, please take normal precaution measures
3. Repair should be carried out by Capp authorized service personnel only.
4. Use original spare parts and accessories only.

1.2. Battery Safety



The CappTronic pipette operates on a small but powerful Lithium-ion battery. Misuse or abuse of the Lithium-ion battery may cause damage or injury through fire, electric shock, or chemical leakage. Please read and understand all warnings before using the battery.

1. When storing the battery, do not allow it to come into contact with any metallic surfaces.

2. Never use the pipette while using the DC-in jack to charge the battery.
3. Do not incinerate the Lithium battery or expose it to excessive heat.
4. Do not short-circuit, puncture, crush, disassemble, damage, deep-cycle, re-vitalize or modify the battery.
5. Do not expose the battery to water or moisture.
6. Do not drop or subject the battery to strong impacts.
7. Only use the battery specified in this manual.
8. Only use the specified, original charger unit to charge the battery.
9. Do not use a leaking battery.
10. If charging is not completed within the specified time period, unplug the charger and discontinue charging immediately.
11. The charger and battery temperature rises with extended periods of use. Care should be taken to avoid burns.
12. Burns may result if the battery is removed immediately after extended periods of use.
13. If fluid from the battery enters your eye, immediately rinse the eye with plenty of running tap water and contact a doctor. If fluid from the battery makes contact with your skin or clothing, wash the area thoroughly with water.

2. General Description

CappTronic features an accurate and efficient, as well as ergonomic and light-weight design. The pipette is designed to conduct various liquid handling tasks in the laboratory with a reduced risk of strain and upper limb disorders.

2.1 Features

- High accuracy and precision
- Force savings
- Useful, practical operation protocols, such as Automatic Pipetting (AUTO), Multiple Dispensing (MD), Mixing(MIX), and Sequential Aspirating/Dispensing (SE), etc.
- Possibility of up to 9 user-defined program settings
- 5 speeds for aspirating and dispensing
- Long operating hours
- Ergonomic design
- Automatic calibration
- Graphic operation interface as easy and user-friendly as a mobile phone
- Adjustable tip ejector height
- Automatic keeping of the last-used pipetting protocol and settings
- Complies with CE, ISO-8655, GLP

3. Getting Started

3.1. Unpacking

Open the package and check whether it contains the following items:

- Single/Multi-channel unit
- Certificate of conformity
- Hanger and accessories
- 1 battery
- User guide
- AC-DC power adaptor
- Pipette tips

If there are any items missing, damaged, or not according to your order, please contact our distributor or sales representatives for replacement immediately.

Please charge up the battery before first-time operation.

3.2. Inserting the Battery

Remove the battery cover by pressing its latch and tilting it to the side (see Figure 1). Insert the battery (see Figure 2) with the metallic contacts facing downwards. Close the cover of the battery compartment.

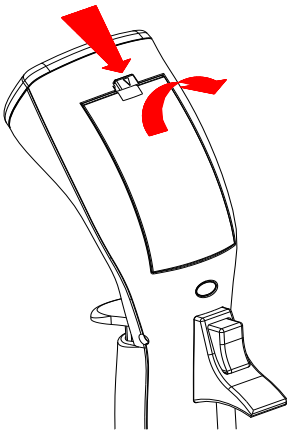

Figure 1: Open the battery cover.

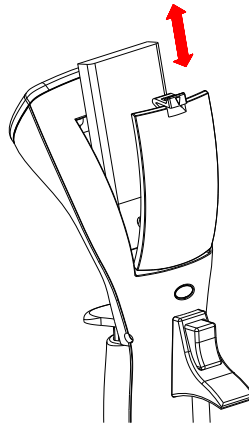

Figure 2: Insert the battery.

Note: After the battery is inserted, the pipette will automatically carry out a calibration routine.

3.3. Charging the Battery

There are two ways to charge the battery: (1) Use the internal charging circuit, (2) Use the charger.

Internal Charging Circuit

Insert the battery into the battery compartment. Insert the DC-in plug of the

power adaptor into the DC-in jack (see Figure 3). Connect the power plug of the power adaptor with the external power source. **Connecting the power plug before inserting the battery will inactivate the charging process.** The indication bar inside battery symbol  will blink during the charging process. When the battery is fully charged, the blinking will stop and the pipette will beep once to remind the user.

Separate Charger

Connect the DC-in plug of the AC-DC power adaptor to the charger. Connect the power plug of the AC-DC power adaptor to the external power source. The indication light will turn green. Insert the battery (see Figure 4). Once the battery is correctly inserted, the indication light will turn red. When the battery capacity is full, the indication light will turn green again.

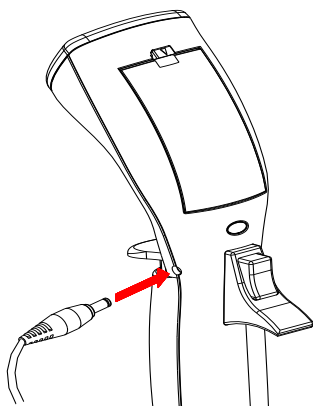

Figure 3: Using the internal charging circuit to charge the battery

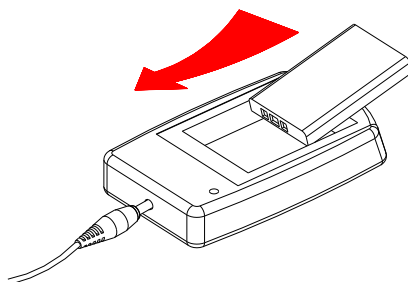

Figure 4: Using the separate charger to charge the battery

Note:

1. *For safety concerns, the pipette shall not be used during the charging period.*
2. *Do not charge the battery for a long period of time.*

3.4. Start Pipetting

There is no power On/Off button on the pipette. Once inserting the fully-charged battery, the pipette will be switched on. It will perform a calibration routine and switch on the LCD display as in Figure 8. Press any keypad button or the **START** button to enter the function mode selection. The pipette will be automatically switched off, if it's not in use for more than 10 minutes.

Select the desired function mode and settings (refer to the following chapters : 6 ~ 10) before pipetting. After the initial set-up, please attach the correct-sized tips to the tip fitting (tip base) of the pipette before operation. By just pressing the **START** button, the pipette will start working.

The CappTronic is ergonomically designed. Hold the pipette as shown in Figure 5. Use your index finger to press the **START** button, and your thumb to press the **TIP** ejector.

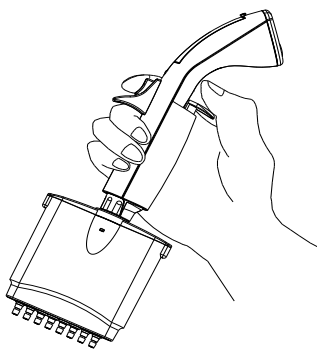

Figure 5: Correct operation

3.5. Hanger Installation

The hanger can be fixed in multiple ways beside the experimental bench by screw or double adhesive tape (inside accessory bag) as shown in Figure 6. The finger rest can be attached to the hanger to keep the pipette in a vertical position.

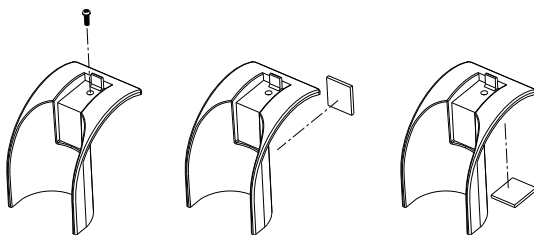

Figure 6: Hanger installation

4. Overview

This section presents an overview of the CappTronic pipette (see Figure 7), and points out the locations of its buttons. The LCD display panel is also shown on page 9 (see Figure 8).

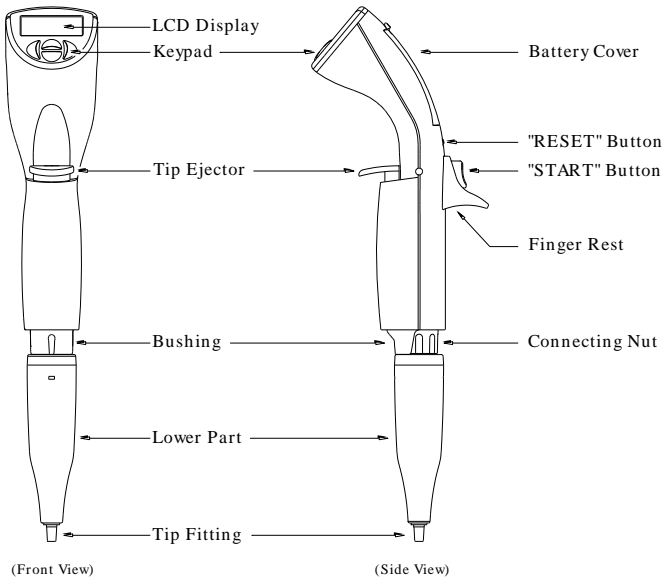

Figure 1 : Overview

Figure 7: 1-channel pipette overview

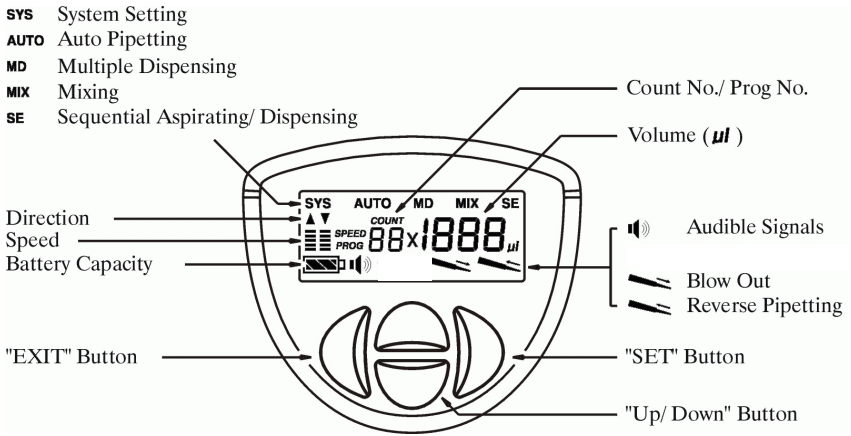

Figure 8: LCD display Panel

4.1. Keypad Function

Button	Symbol	Function Description
Set/Enter		Confirms your choice
Exit/Esc		Exits to previous mode/setting
Up		Increases volume/ changes parameter
Down		Decreases volume/ changes parameter
Reset		Piston automatically determines the home position
Start		Activates aspirating/dispensing/ Replace
Tip Ejector		Ejects the tips

Tips On Efficient Operation: **START** button can be used to increase volumes, and to change modes and settings as “Up” button during the function mode selection and volume settings. This unique design will speed up the setting processes.

4.2. Acoustic Signals

The acoustic signals are a great help when you are familiarizing yourself with the operating procedure of the CappTronic pipette. They can also be switched off if required (see Section 6.3.)

Acoustic Sound	Operation
Low-tone beep	Aspirating
High-tone beep	Dispensing / Error codes
2 beeps	MD/MIX/SE mode cycle or RESET routine is completed

5. Function Map

The main menu of the pipette includes five function modes (SYS, AUTO, MD, MIX and SE). Each mode includes various function settings (see Figure 9).

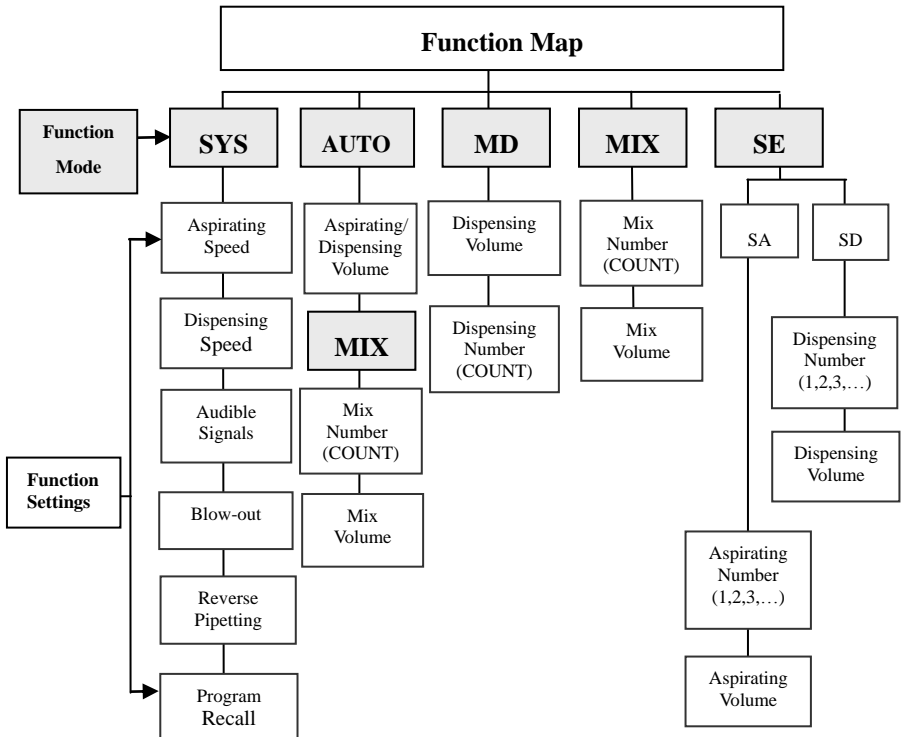



Figure 9: Function map

6. SYS (System) Mode







SYS mode is used to set up the function settings before pipetting. Once users select and store these settings, they will no longer need to set up the settings before every pipetting. There are 6 function settings (Aspirating Speed, Dispensing Speed, Acoustic Signals, Blow-out, Reverse Pipetting and Program Recall) in SYS mode.

Note :





1. *These 6 function settings are sequential procedures. To store these settings in memory, you have to complete the whole setting procedure and press  «SET» when the LCD displays **PROG** .*
2. *You can use the  «Up/Down» button to move back and forth to the previous function settings.*

6.1. Aspirating Speed

There are 5 speeds available for both aspirating and dispensing:





1. Press  «EXIT» to enter the function mode selection. Then press  «Up/Down» repeatedly until the **SYS** symbol starts flashing.
2. Press  «SET» to confirm the selection of **SYS** mode and the aspirating speed symbol  will start flashing.
3. Press  «Up/Down» to change the aspirating speed
⎵: Slowest, ≡: Fastest.
4. Press  «SET» to confirm the speed selection and move to the “Dispensing Speed” function setting.

6.2. Dispensing Speed

1. The “Dispensing Speed” symbol  should now be flashing.
2. Press  «Up/Down» to change the aspirating speed
: Slowest, : Fastest.
3. Press  «SET» to confirm the speed selection and move to the “Acoustic Signals” function setting.









6.3. Acoustic Signals

Please refer to Section 4.2 for the definition of “Acoustic Signals”.

1. The “Acoustic Signals” symbol  should now be flashing.
2. Press  «Up/Down» to select the preference (: On, : Off).
3. Press  «SET» to confirm the selection and move to the “Tip Ejection Alarm” setting.

6.4. Blow-out

The automatic blow-out function, in different pipetting modes, simulates the blow-out function in manual pipettes. **To avoid the leftover final droplet in tips, the blow-out setting is recommended in all protocols.** The blow-out setting will not be performed in “Reverse Pipetting” setting.





1. The “Blow-out” symbol  should now be flashing.
2. Press  «Up/Down» to select the preference (: On, : Off).
3. If  is selected, pressing  «SET» will confirm the selection and move to the “PROG” setting. If  is selected, pressing 

«SET» will confirm the selection and move to the “Reverse Pipetting” setting.

Note: It is important to withdraw the tip quickly from the dispensing sample vessel after dispense if Blow-out is selected, because the piston will retract a short distance for creating the blow-out volume.

6.5. Reverse Pipetting

The automatic reverse pipetting, in different pipetting modes, is to reserve the final drop of sample. The pipette will not perform the reverse pipetting in MIX or SE modes.

1. The “Reverse Pipetting” symbol  should now be flashing.
2. Press  «Up/Down» to choose the preference (: On, : Off).
3. Press  «SET» to confirm the selection and move to the “PROG” setting.



*Note: If reverse pipetting is selected, you will have to press the START button one more time to dispense the remaining liquid during the pipetting. **rE** will appear on the LCD to remind users to dispense the remaining liquid.*

6.6. Setting PROG (Programs)





The memory program includes 9 different storage locations (PROG 01 ~ 09). Your favorite operating modes with user-selected settings can be stored to these locations for future recalls. Before setting the programs, you must have

programmed operating mode (e.g. AUTO, MD mode, etc).

Store Operating Mode to Storage Locations

1. Complete the setup of function mode (e.g. AUTO, MD, MIX mode).
2. Press and hold  «SET» for 3 seconds to enter PROG mode.
3. Press  «Up/Down» to select PROG number from 01 ~ 09.
4. Press  «SET » to confirm the location selection and save the functions.





Recall Stored Programs from the Storage Location

1. Press  «EXIT» to enter the function mode selection. Then press  «Up/Down» repeatedly until the **SYS** symbol starts flashing.
2. Press  «SET» repeatedly to confirm the selection of all 6 function settings until the **PROG** symbol starts flashing.
3. Press  «Up/Down» to select the PROG number.
4. Press  «SET» to confirm the selection.
5. Press the START button to operate the pipette in the selected program.

Note: During the recall process, the changes of other settings will not be stored.

7. AUTO Mode







In the AUTO mode, the pipette performs the aspirating and dispensing of the set liquid volume.

1. Press  «EXIT» to enter the mode selection, which causes the **AUTO** symbol to start flashing. If not, press  «Up/Down» to select AUTO mode and make it flashing.
2. Press  «SET» to confirm the mode selection.
3. Use  «Up/Down» to select the desired pipetting volume.
4. Press  «SET» to confirm selected volume and readiness for pipetting.

Tip: You may use the **START** button to replace  «Up» to speed up the volume setting.

8. MD (Multiple Dispensing) Mode







In MD mode, the CappTronic performs repetitive dispensing of a selected volume. To compensate for the possible mechanical gap, and to blow out the residual volume in the end of every multiple dispensing cycle completely, Reverse Pipetting(RE) has become the default setting in Multiple Dispensing(MD) mode. If the reversed function is performed, the sum of the dispensing aliquots and an automatically selected excess volume is aspirated into the tip. The excessive volume is needed to ensure equal operating condition for each dispensing step.

1. Press  «EXIT» to enter the mode selection.
2. Press  «Up/Down» to make the **MD** symbol start flashing.
3. Press  «SET» to confirm the selection. The **COUNT** symbol will then appear.
4. Use  «Up/Down» to select the desired pipetting count.
5. Press  «SET» to confirm the selection of count. The default pipetting volume will start flashing.
6. Use  «Up/Down» to select the desired pipetting volume.
7. Press  «SET» to confirm the pipetting volume. The pipetting volume will show the total aspirating volume.
8. After the settings are completed, firstly , press the START button to aspirate the sample according to the pipetting volume. Next, continue to press the START button to dispense the samples according to the pipetting counts. When the count becomes “0”, press the START button and LCD will display **RE**. Press the START button one more time to discard the remaining liquid. Press the START to aspirate the

sample again. By pressing the **START** button, the whole operation cycle will automatically repeat.

9. MIX Mode

After the settings are completed, Mixing is performed automatically as long as the **START** button is held down or with just one touch of the **START** button, the pipette also can finish the programming.









1. Press  «EXIT» to enter mode selection.
2. Press  «Up/Down» repeatedly until the **MIX** symbol starts flashing.
3. Press  «SET» to confirm the selection. The **COUNT** symbol will then appear.
4. Use  «Up/Down» to select the desired mixing count
5. Press  «SET» to confirm the selection. The default pipetting volume will start flashing.
6. Use  «Up/Down» to select the desired mixing volume.
7. Press  «SET» to confirm the selection. The total mixing volume and counts will be displayed.
8. Press the **START** button to start the mixing function. After the completion of mixing, pressing the **START** button will re-activate the mixing process until the user changes the function mode.

10. SE (Sequential Aspirating/Dispensing) Mode

SE mode includes SA (Sequential Aspirating) mode and SD (Sequential Dispensing) mode.

10.1. SA (Sequential Aspirating) Mode

The pipette performs repetitive aspirations of the selected volumes. An air gap will be created automatically between two aspirations. When the sequential aspiration is completed, the next operation will dispense all of the aspiration volume together.

1. Press  «EXIT» to enter function mode selection.
2. Press  «Up/Down» repeatedly until the **SE** symbol starts flashing.
3. Press  «SET» to confirm the selection.
4. Use  «Up/Down» until the **SA** symbol starts flashing.
5. Press  «SET» to confirm the selection.
6. Under the **COUNT** symbol, “01” will appear. Press  «Up/Down» to set the volume of the first aspiration.
7. Press  «SET» to confirm the selection.
8. Repeat steps 6 and 7 to set the sequential aspiration volumes. The total aspirating volume (including air gap volume) cannot exceed maximum volume range.
9. Press  «SET» to confirm the selection.
10. The count “01” and aspirating volume will appear on the display. The pipetting direction and speed  will flash to indicate that the pipette

is ready for liquid pick-up. Press the **START** button to aspirate the samples. **R** will appear to remind users to create an air gap between sample aspirations.



11. When the aspirations are completed,  will flash to indicate the pipette is ready for dispensing.
12. After the sequential aspirating cycle, the pipette will make two beeping sounds. Pressing the **START** button will re-activate the whole cycle again until users change the function mode.







Note:

1. *If the blow-out setting is selected, the pipette will automatically blow-out the liquid during sequential aspiration mode.*
2. *E1000 models do not include the Sequential Aspirating (SA) function, because the air gap is not strong enough to support the weight of samples.*
3. *Sequential Aspirating (SA) function will not perform Reverse Pipetting even it is selected in System(SYS) mode.*

10.2. SD (Sequential Dispensing) Mode

The CappTronic performs repetitive dispenses of the selected volumes. When the first aspiration is completed, the pipette will sequentially dispense the aspiration volume.

1. Press  «EXIT» to enter function mode selection.
2. Press  «Up/Down» repeatedly until **SE** symbol starts flashing.
3. Press  «SET» to confirm the selection.

4. Press  «Up/Down» repeatedly until **5d** symbol starts flashing.
5. Press  «SET» to confirm the selection.
6. Under **COUNT** symbol, “01” will appear. Press  «Up/Down» to set the volume of the first dispense.
7. Press  «SET» to confirm the selection.
8. Repeat steps 6 and 7 to set the sequential dispensing volumes. **The total dispensing volume cannot exceed maximum volume range.**
9. Press  «SET» to confirm the selection.
10. The count “01” and the total aspirating volume will appear on the display. The pipetting direction and speed  will flash to indicate the pipette is ready for liquid pick-up. Press the **START** button to aspirate the samples. When the aspirations are completed, the dispensing count and volume will appear and  will flash to indicate that the pipette is ready for dispensing.
11. After the sequential dispensing cycle, the pipette will make two beeping sounds. Pressing the **START** button will re-activate the whole cycle until the user changes the function mode.

***Note:** If the blow-out setting is selected, the pipette will automatically blow-out the liquid during sequential aspiration mode.*

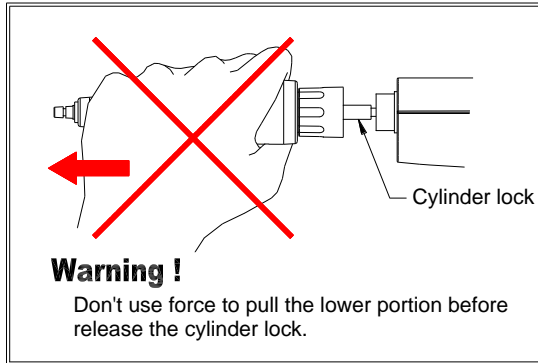

Figure 10: Wrong operation of Lower Part disassembly

11. Sterilization

Only the lower part of pipette can be steam-autoclaved (121°C, 1 bar, 20 minutes). The autoclaved parts must be allowed to dry completely at room temperature for at least 2 hours. You can follow Figures 11~14 to disassemble the pipette.. **DO NOT** use excessive force to pull down the lower part before releasing the cylinder lock as shown in Figure 10. This action may break the connection mechanism of the lower part.

11.1. Disassemble Lower Part



Always remember to press **RESET** button before you disassemble the lower part of the pipette.

1. Press the **RESET** button. Wait until you hear two beeps.
2. Loosen the lower part of the pipette by rotating the connecting nut in the clockwise direction as shown in Figure 11.

3. Pull the lower part downward **slowly** until the cylinder lock appears as shown in Figure 12.
4. **Please place the pipette on a flat surface.** Push the cylinder lock downwards until you hear a click sound as shown in Figure 13.
5. The lower part will come off easily and automatically as shown in Figure 14.

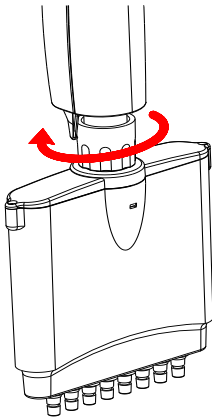

Figure 11: Rotate the connecting nut clockwise.

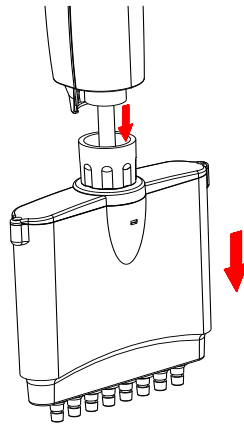

Figure 12: Pull the lower part downward **slowly** until the cylinder lock appears.

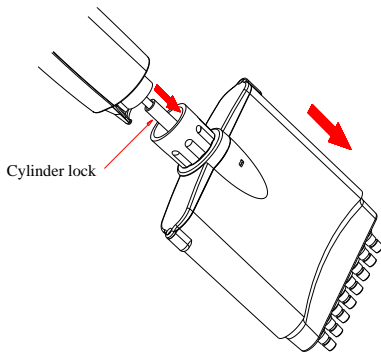

Figure 13: Push the cylinder lock downward until you hear a click sound.

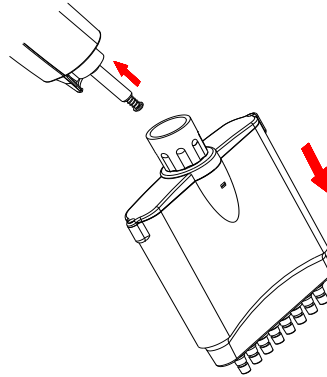

Figure 14: The lower part will come off easily and automatically.

11.2. Reassemble Lower Part



Always remember to press **RESET** button after you reassemble the lower part of the pipette.

Follow these steps to reassemble lower part of the pipette:

1. Press the **START** button or any button of the keypad to make the step motor shaft retract inside of upper part for 1 cm. The step motor will automatically retract inside of upper lower part if users do not touch any button for 10 minutes.
2. Connect the lower part with connecting nut. Tighten up the connecting nut.
3. Press the **RESET** button. The step motor shaft will connect with the piston of the lower part automatically. After the connection is completed, the pipette will beep twice.

12. Maintenance

The outside of the pipette may be wiped clean with 60% Isopropanol, 70% ethanol or a suitable detergent such as Trigene™, and then wiped with a lint-free cloth. If the pipette is contaminated or if corrosive chemicals are dispensed, the lower part of the pipette should be disassembled and rinsed. The individual parts should be decontaminated with a suitable detergent, rinsed in distilled water and then air dried.

It is recommended to clean the pipette at regular intervals depending on how much the pipette is used, as well as lubricating it once per year. If the pipette is heavily used or autoclaved often, you may need to lubricate the pipette more frequently. Only Capp trained representatives or users are recommended to lubricate the piston. Please use the lubricant as offered by Capp only.



It is recommended to check the performance of your pipette regularly (e.g. every 3 ~ 6 months). Thus users should establish a regular testing routine for their pipette having regard to the accuracy requirements of the application, frequency of use, number of operators using the pipette, nature of the liquid dispensed and the acceptable maximum permissible errors established by the user (ISO 8655-1). For maintenance, please contact your CappTronic dealer or authorized service provider. You may find useful additional information on our website, www.capp.dk

***Note:** Using improper lubricants will deter or block the movement of the piston of the pipette and will cause loss of warranty.*

13. Troubleshooting

To ensure the product quality, the pipette is designed with a self-diagnosis program. This program will constantly monitor the accuracy of pipetting volume, battery status and auto-calibration function. Error (Err) messages will appear on the display if the pipette fails to perform the attempted action properly. In case any Error (Err) messages or faults occur, please refer to the solutions in the following table to clear the error messages or faults.

If the following solutions are not able to resolve the problem, please return your pipette to your CappTronic dealer or an Capp authorized service provider for repair.

Symptom	Possible Cause	Solution
“Err 01”	Bad battery	Charge the battery
	Bad power adaptor	Replace the power adaptor
“Err 02”	Auto-calibration is not working	Press the  button
“Err 03”	Inaccurate pipetting volume	Press the  button
“Err 04”	Step motor failure	Press the  button
	Photo-couple failure	
Droplets left inside	Unsuitable tip	Use high-quality

the tip		tips
Leakage or volume too small	Non-uniform wetting of the plastic tip	Rinse the tip
	Tip incorrectly attached	Attach firmly
	Unsuitable tip	Use high-quality tips
Fail to aspirate	Low battery	Charge the battery
	The lower part doesn't hook up correctly with motor shaft	Reassemble the lower part one more time
	Foreign objects block the tip fitting's channel	Use MIX mode and distilled water to wash away the foreign objects
	Piston blocks	Lubricate piston
Power on failure	Bad battery contact	Reinsert the battery
	Rusted battery contact	Replace with new battery
	Dead battery	Charge the battery
Function Mode setup failure	Tip Ejector can't bounce back	Adjust Tip Ejector position

Appendix A: Technical Specifications

Operation Mode	Automatic Pipetting (AUTO), Multiple Dispensing (MD), Mixing (MIX), Sequential Aspirating/Dispensing (SE), System Setup (SYS)
Memories	9 sets
Aspirating/Dispensing Speed	5 speeds
Auto-calibration	Yes
Power Engine	High precision stepping motor
Power Saving	Yes, after 10 minutes
Power Adaptor	100/120/220/240 V AC-DC 3.6 V
Acoustic Indication	Yes
Autoclavable	Yes, for lower part only
Operating Temperature	5 ~ 50°C
Operating Humidity	RH: 0 ~ 85%
Battery	900 mAh/3.6 V or above
Battery Charger	Optional
Stand for 3 units	Optional
Certification	Complies with CE, Class A (EN60101-1-2, EN50082-1, EN 55011) Complies with ISO-8655/ DIN 12650

Note:

1. *U.S. patents pending*
2. *Specifications are subject to change without prior notice*

Appendix B : Tip Ejector Height Adjustment

1. Remove the lower part of pipette as described in Section 11.1.
2. Remove the flat-head screw and bushing as shown in Figure 15.
3. Use flat-head screwdriver or other tool to rotate the tip ejector height adjustment nut. By rotating the nut in counter-clockwise direction, the tip ejector will move closer to the mouth of tip fitting. This height adjustment will enable the pipette to accommodate to a wider range of tips.

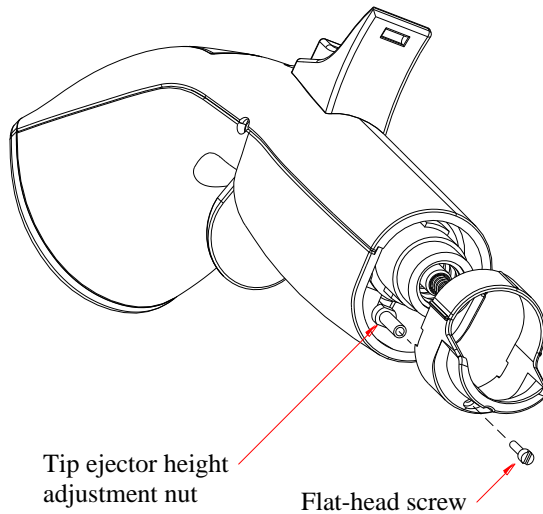

Figure 15 Tip ejector height adjustment

Appendix C: Warranty

The CappTronic electronic pipettes are covered by a warranty for one year against defects in materials and workmanship. This period begins from the date of purchase, and within this period all defective parts will be replaced. The warranty does not cover defects caused by excessive tear and wear or damage due to shipping, accident, abuse, misuse, problems with electrical power, or usage not in accordance with product instructions, or if other than original spare parts supplied by the manufacturer have been used.

Each pipette is tested and documented by the manufacturer before shipping. Capp Quality Control System guarantees that the performance of the CappTronic pipette you have purchased is within its specifications.

YOUR NOTES

Printed in Taiwan

P/N: 401-CappTronic-33

20201231