



**MADE**inITALY

# CATALOGUE**2020**



BIOTECHNOLOGY AND CLINICAL CHEMISTRY PRODUCTS

**CLEARLine**<sup>®</sup>  
*"Be cool, be safe, be CLEARLine"*



## Company Profile

Since 1988 Biosigma S.r.l. produces and distributes disposable plastic items for biotechnology, research, clinical chemistry and pharmaceutical laboratories.

In our over 12,000 sqm facilities, we dispose of latest injection machines and informatics tools that allow production of high standard quality articles still being competitive on the worldwide market

Every customer can count on a perfectly organized structure, ISO 13485, OHSAS 45001 and ISO 14001 certified, able to adapt our biotechnology products and services to continuous demands of the market. We offer our customers experience and professional competence; customer satisfaction and quality of our products are always our main targets.

Our efforts in research and development allow us to offer a growing and more advanced range of products both in Clinical Chemistry and Biotechnology fields.

Biosigma's manufacturing are CE marked in accordance with 98/79/EC directive related to In Vitro Diagnostic Medical Devices.

Since August 2011 Biosigma became part of Dominique Dutscher Group, leader in the distribution of consumables and equipments for life science and biotechnology market. Over 60,000-product catalogue and more than 140 brands such as Eppendorf, Thermo, Gilson, Nalgene Nunc.

For further information visit [www.dutscher.com](http://www.dutscher.com)



## Certifications



*" Biosigma is always focused on the safety and the quality of its work reaching the most important certifications "*

ISO 13485 Quality System Certificate demonstrates and promotes the company's commitment to organizational policies aimed at providing products and services in line with regulatory and market requirements related to the medical field.



ISO 14001 is a tool that will allow the organization to manage the environmental impacts of its activities in accordance with the applicable law, continuous improvement, from a pro-active attitude towards environmental issues.



The certification of the management system of health and safety in the workplace UNI ISO 45001:2018 is intended to provide security and tranquility that problems regarding the safety and health related to production processes are managed in a controlled way and that benefits in terms of safety are always monitored starting from the respect of conformity to mandatory legislation.



Registration Number: 3002945499

The production establishment and IVD Biosigma devices are registered with the FDA (Food and Drug Administration).

## CE Directive



Most of the products manufactured by Biosigma, are CE marked in accordance with 98/79/EC Directive related to in vitro diagnostic medical devices. CE certification attests that the company assumes specific responsibilities related to the compliance of the devices to all the Community rules which provide for their use: from design to manufacturing, placing on the market, putting into service of the product to disposal .

## Contacts



Phone:  
+39 0426 302226



Fax:  
+39 0426 302228



Email:  
export@biosigmaeu.com



Address:  
Biosigma S.r.l. a Dutscher company  
Via Valletta, 6 - 30010,  
Cona (VE) Italy



International Web-Site:  
www.biosigma.com



Opening Time (UTC+1.00):  
From Monday to Friday :  
08:30 AM - 01:00 PM  
02:00 PM - 05:30 PM

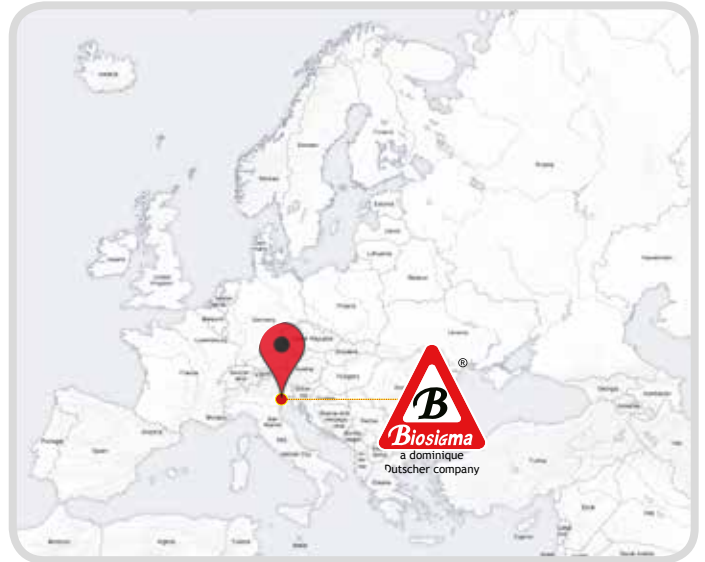

adherent to:  **CONFINDUSTRIA VENEZIA**  
AREA METROPOLITANA DI VENEZIA E ROVIGO

member of:  **ESBB**  
European, Middle Eastern  
& African Society  
for Biopreservation  
and Biobanking

## Our Team



*Stefania Pizzeghello*  
Export Manager

Phone: +39 0426 302226 int. 101  
Email: export@biosigmaeu.com  
Skype: biosigma\_stefania  
Mobile: +39 338 6647513



*Mattia Saviolo*  
International Sales:  
North/West Europe

Phone: +39 0426 302226 int. 130  
Email: exp.logistic@biosigmaeu.com  
Skype: biosigma\_mattia  
Mobile: +39 342 6135424



*Alessandra Bolzonaro*  
International Sales:

East Europe, Africa, Australia,  
North/Central/South America

Phone: +39 0426 302226 int. 144  
Email: exp.support@biosigmaeu.com  
Skype: biosigma\_exp.support  
Mobile: +39 349 6771961



*Debora Aggio*  
Marketing

International Sales:  
Asia, Middle East

Phone: +39 0426 302226 int. 169  
Email: exp.marketing@biosigmaeu.com  
Skype: biosigma\_qualita  
Mobile: +39 349 8635246

REMEMBER TO **SUBSCRIBE**  
TO OUR NEWSLETTERS ON  
**WWW.BIOSIGMA.COM**



## Summary

### CRYOWARE..... 10-27



<b>1D CRYOLINE</b>	<b>11</b>
CryoGen® Tubes / 1D linear barcode CLEARLine®	11
CryoGen® Tubes / 1D linear barcode INTERNAL CAP Tubes CLEARLine®	12
CryoGen® Tubes / 1D linear barcode EXTERNAL CAP Tubes CLEARLine®	13
Cryoboxes in polycarbonate	14
1D Cryoboxes in polycarbonate	15
<b>2D CRYOLINE</b>	<b>16</b>
CryoGen® Tubes / 2D barcode CLEARLine®	16
2D Cryoboxes in polycarbonate 81 and 100 places	17
48 Places SBS rack for 2 and 5 ml 2D CryoGen® tubes	18
Fully automatic capper / decapper for 48 places SBS rack	18
SINGLE SCREW DECAPPERS for CryoGen® Tubes	19
Fully automatic capper / decapper	19
SBS 2D Coded storage tubes 450 and 980 µl	20
SBS Caps	20
Cappers - Decappers	21
Scanners	21
Software for sample management	22
<b>ACCESSORIES</b>	<b>23</b>
Writing cap disks	23
Cryo Markers	23
Workstation for CryoGen® Tubes	23
Vial Picker for CryoGen® Tubes	23
Cryoboxes in polypropylene	24
Cardboard Cryoboxes CLEARLine®	24
Cardboard Cryoboxes	24
Cryogenic gloves	25
Support rod for canisters	25
Cryoflex sheath	25
<b>COOLING CONTAINERS</b>	<b>26</b>
CoolCell containers	26
Cryocooler	26
Freezing Rack	26

### MICROCENTRIFUGE TUBES..... 28-35



<b>MICROCENTRIFUGE TUBES WITH SCREW CAPS</b>	<b>29</b>
<b>CLEARLock® MICROTUBES WITH SECURE LOCKING SYSTEM</b>	<b>30</b>
0.5 - 1.5 - 2.0 mL Microtubes CLEARLock®	30
5.0 mL Microtubes CLEARLock®	31
5.0 mL Microtubes screw cap	32
Accessories for 5.0 mL tubes	32
5.0 mL acrylic tube rack	33

5.0 mL / 15 mL tube rack	33
Myfuge 5 microcentrifuge	33
Centrifuges adapters and accessories for 5.0 mL tubes	33
<b>MICROCENTRIFUGE TUBES WITH SNAP CAPS</b>	<b>34</b>
Microtubes in PP 0.5, 1.5 and 2.0 ml	34
Microtubes in PP 0.5, 1.5 and 2.0 ml CLEARLine®	34
<b>RACKS FOR MICROCENTRIFUGE TUBES</b>	<b>35</b>
4-Way Racks	35
Racks for 100 microtubes	35
Racks for 80 microtubes, storage box and acrylic shelves	35

### CELL CULTURE..... 36-39



<b>CENTRIFUGE TUBES</b>	<b>37</b>
CLEARLine® Centrifuge Tubes	37
Conical centrifuge tubes - large volume	38
EASYstrainer sterile cell strainers	38
<b>CELL CULTURE FLASKS</b>	<b>38</b>
<b>MULTIWELL CELL CULTURE PLATES</b>	<b>39</b>
<b>AERASEAL POROUS FILM</b>	<b>39</b>
<b>CLEARLINE PETRI DISHES</b>	<b>39</b>
<b>CELL SCRAPERS</b>	<b>39</b>
<b>THINSEAL &amp; SEALPLATE STERILE FILM</b>	<b>39</b>

### PCR AND PLATES..... 40-45



<b>PCR MICROTUBES</b>	<b>40</b>
PCR microtubes 0.2 ml Mµliti	41
PCR microtubes ABgene	41
PCR microtubes - 0.65ml Mµliti	41
Individual PCR tubes 0.2 ml	41
Safeseal microtubes - 0.65 ml	41
<b>PCR MICROTUBES IN STRIP</b>	<b>42</b>
PCR Microtubes 0.2 ml in strip Mµliti	42
ABgene® single cap microtubes in strips	42
Thermo-strip standard tubes	42
PCR Microtubes 0.2 ml in strip with cap	42
<b>PCR MULTI-MICROTUBE RACKS</b>	<b>43</b>
<b>STACKABLE RACK FOR PCR</b>	<b>43</b>
<b>STORAGE BOX WITH RACK FOR PCR PLATES</b>	<b>44</b>
<b>ADHESIVE FILMS</b>	<b>44</b>
<b>PCR PLATES FASTPLATE MµLTI</b>	<b>45</b>
<b>SEMI-SKIRTED 96-WELL PCR PLATES, MµLTI REINFORCED</b>	<b>45</b>
<b>PCR PLATES 96 AND 384 WELLS FOR LIGHT CYCLER®</b>	<b>45</b>
<b>PCR PLATES 384 WELLS µLTRA-PLATE MµLTI</b>	<b>45</b>

## Summary

### LIQUID HANDLING ..... 46-57



### URINE READING SYSTEM..... 64-69



<b>ASPIRATION SYSTEM FOR SEROLOGICAL PIPETTES</b>	<b>46</b>
Automatic pipettor	46
Manual pipettor	46
<b>CLEARLine® SEROLOGICAL PIPETTES</b>	<b>47</b>
<b>MICROPIPETTES WITH EJECTORS FULLY AUTOCLAVABLE</b>	<b>48</b>
Fix volume	48
Adjustable volume	48
Multichannel 8 channel	49
Rack	49
<b>STERILE PS REAGENT RESERVOIRS IN 25, 50, 100 ml</b>	<b>49</b>
<b>STANDARD TIPS</b>	<b>50</b>
Tips compatibility with micropipettes	51
<b>CLEARLine® STERILE FILTER TIPS, RACKED</b>	<b>52</b>
Tips compatibility with micropipettes	53
<b>CLEARLine® FILTER AND STANDARD TIPS</b>	<b>54</b>
Tips CLEARLine®	54
CLEARLine® reload system	55
Empty boxes for CLEARLine® reload system	55
<b>ONE TOUCH® BI-COMPONENT TIPS</b>	<b>56</b>
<b>Multi SORENSON ONE TOUCH PIPETTES</b>	<b>56</b>
<b>PASTEUR PIPETTES</b>	<b>57</b>

<b>FOR STANDARDIZATION OF MICROSCOPIC URINALYSIS</b>	<b>65</b>
M-T system	66
Calculation method for cells / $\mu$ l in urinary sediment	66
<b>How to order FAST-READ® kits</b>	<b>67</b>
Urinalysis controls validate performance for consistency and accuracy	67
<b>STAN-TAP &amp; STAN-TAP SYSTEM</b>	<b>68</b>
Integrated system for the standardized preparation of the urinary sediment	69

### HISTOLOGY AND MICROSCOPY ... 70-75



### INSTRUMENTATION PRODUCTS . 58-63

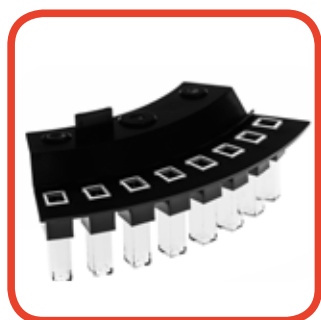

<b>CUVETTES AND CUPS UTILIZABLE ON COBAS®</b>	<b>59</b>
<b>CUVETTES AND CUPS UTILIZABLE ON HITACHI®</b>	<b>59</b>
<b>12 CELLS CUVETTE</b>	<b>60</b>
<b>CUVETTES UTILIZABLE ON EXPRESS®</b>	<b>60</b>
<b>SAMPLE AND COAGULATION CUPS</b>	<b>61</b>
<b>EASY NEST CUPS</b>	<b>61</b>
<b>SEMI-MICRO AND MACRO CUVETTES</b>	<b>62</b>
Disposable spectrophotometer cuvettes in PS and PMMA	62
Macro	62
Semi-micro	62
Quartz or Optical Glass Macro and Semi-Micro cuvettes	63

<b>EMBEDDING CASSETTES</b>	<b>70</b>
Embedding cassette without lid	70
Metal Lid	70
Embedding ring	70
Histology cassettes	71
Mould base stainless steel	71
Biopsy cassettes	71
Histological sponge	71
<b>MICROSCOPE SLIDES</b>	<b>72</b>
<b>COVERSLIPS</b>	<b>72</b>
<b>HISTOBOND®</b>	<b>72</b>
<b>COVERSLIPS FOR AUTOMATIC MACHINES</b>	<b>72</b>
<b>PLASTIC TRAYS AND SLIDES MAILERS</b>	<b>73</b>
<b>STORAGE MICROSCOPE SLIDE BOXES</b>	<b>73</b>
<b>SLIDE STORING SYSTEM</b>	<b>73</b>
<b>COPLIN STAINING JAR</b>	<b>74</b>
<b>HELLENDAHL STAINING JAR</b>	<b>74</b>
<b>OILS FOR IMMERSIONS</b>	<b>74</b>
<b>SCHIFFERDECKER STAINING BOX</b>	<b>74</b>
<b>STAINING JAR WITH 2 LIDS</b>	<b>74</b>
<b>EUKITT BALM FOR INCLUSIONS</b>	<b>74</b>
<b>COUNTING CHAMBER</b>	<b>75</b>
<b>MEMBRANE IN PC</b>	<b>75</b>
<b>MAKLER CELL</b>	<b>75</b>
<b>POLYCARBONATE MEMBRANES</b>	<b>75</b>

## Summary

### MICROBIOLOGY ..... 76-81



<b>INOCULATION LOOPS</b>	<b>77</b>
<b>STERILE L-SHAPED SPREADERS</b>	<b>78</b>
<b>PETRI DISHES</b>	<b>78</b>
<b>SWABS</b>	<b>79</b>
<b>FOAM SWABS WITH LIQUID</b>	<b>80</b>

### TEST TUBES, STOPPERS, RACKS ..... 82-89



<b>CLEARLine® CENTRIFUGE TUBES</b>	<b>82</b>
<b>STERILE PP &amp; PS CENTRIFUGE TUBES WITH SCREW CAPS</b>	<b>83</b>
<b>FLAT BOTTOM TEST-TUBES WITH SCREW CAPS</b>	<b>83</b>
<b>STERILE POLYSTYRENE TEST-TUBES WITH PRESSURE CAPS</b>	<b>83</b>
<b>VACUUM TUBES FOR URINE ANALYSIS</b>	<b>84</b>
<b>SERUM SEPARATOR TUBES IN RACK</b>	<b>84</b>
<b>TEST TUBES WITH TWO-POSITION CLOSURE CAP</b>	<b>84</b>
<b>VACUUM URINE CONTAINERS</b>	<b>84</b>
<b>NON STERILE TEST-TUBES</b>	<b>85</b>
<b>DROSOPHILA</b>	<b>86</b>
<b>CAPS</b>	<b>86</b>
Polyethylene stoppers with wings	86
White R.I.A. stoppers	86
Vacustopper™	86
Security stoppers for tubes	86
Polyethylene stoppers	86
<b>CRYOGENIC STORAGE BOXES FOR VACUUM TUBES</b>	<b>87</b>
50 places racks	87
Rack for haemolysis tubes	87
Box for tubes 15, 20, 30 and 50 mL with lid	88
Rack for 15 mL and 50 mL tubes	88
Racks for 15 and 50 mL tubes	88
5ml / 15 mL tube rack	88
Acetal multi-racks	88
Reversible multi-sided racks	89
Barrel rack	89

### E.S.R. SYSTEM..... 90-91



<b>E.S.R. PIPETTES</b>	<b>91</b>
<b>E.S.R. TUBES</b>	<b>91</b>
<b>E.S.R. RACKS</b>	<b>91</b>

### RAPID TESTS ..... 92-97



<b>FECAL OCCULT BLOOD TEST</b>	<b>93</b>
<b>PREGNANCY RAPID TESTS</b>	<b>93</b>
<b>ONE STEP DRUG SCREEN TEST DEVICE (URINE)</b>	<b>94</b>
<b>INFECTIOUS DISEASES</b>	<b>96</b>
<b>CALPROTECTIN</b>	<b>96</b>
<b>PARASSITOLOGY</b>	<b>97</b>
<b>URINE ANALYSIS</b>	<b>97</b>
<b>CONSUMABLES</b>	<b>97</b>

### CONTAINERS ..... 98-101



<b>URINE CONTAINERS WITH SCREW CAPS</b>	<b>99</b>
<b>FEACES CONTAINERS</b>	<b>99</b>
<b>SPECIMEN CONTAINERS</b>	<b>99</b>
<b>SURGICAL PART CONTAINERS</b>	<b>100</b>
<b>24-HOUR CONTAINERS</b>	<b>100</b>
<b>VACUUM URINE CONTAINERS</b>	<b>100</b>
<b>WATER SAMPLING BOTTLES</b>	<b>100</b>
<b>WASTE CONTAINERS</b>	<b>101</b>

### TRANSPORT LINE ..... 102-107



<b>TRANSPORT LINE FOR BIOLOGICAL SAMPLES</b>	<b>103</b>
Transport bags	103
Suitable for secondary container CTP	103
Duplex racks	103
Transport Container (CTP) for tubes	103
Racks in absorbent foam	103



## Summary

<b>TRANSPORT LINE IN ACCORDANCE WITH ADR NORMS</b>	<b>104</b>
Bags for secondary container transport in accordance with ADR norms	104
VACUETTE® Transport Box (VTB)	104
Racks in absorbent foam for secondary containers	104
VACUETTE® Transport Container (VTC)	104
<b>TRANSPORT LINE FOR CHEMOTHERAPEUTICS SAMPLES</b>	<b>105</b>
Transport bags for chemotherapeutics samples, suitable for secondary container CTP	105
Duplex racks for BS472041/C	105
Transport Container (CTP) for chemotherapeutics samples	105
Racks in absorbent foam	105
<b>TERTIARY CONTAINERS FOR BLOOD COMPONENTS</b>	<b>106</b>
Bags for blood component and biological sample transportation,	106
Transport of blood bags	106
<b>ACCESSORIES</b>	<b>107</b>
Cooler Elements	107
Refrigerated container for single tubes	107
Specimen transport bags	107
Security bags	107
<b>FIRST AID BAGS</b>	<b>107</b>
First aid bag with 4 external pockets	107
First aid bag with 5 external pockets and 3 internal pockets	107
Non-rigid container	107

## HEALTH AND SAFETY ..... 108-109



<b>PARAFILM</b>	<b>108</b>
<b>GEN-X Nitrile gloves</b>	<b>108</b>
<b>NITRILE GLOVES</b>	<b>109</b>
<b>CRYOGENIC GLOVES</b>	<b>109</b>
<b>LATEX GLOVES</b>	<b>109</b>

## GINECOLOGY AND FERTILITY ..... 110-111



<b>SEMEN COLLECTION</b>	<b>111</b>
<b>SPRAY FOR CITOTOLOGY</b>	<b>111</b>
<b>EJACULATE SLIDE-READ BOX</b>	<b>111</b>
<b>VAGINAL SPECULUM</b>	<b>111</b>
<b>AYRE SPATULES</b>	<b>111</b>
<b>CYTOBRUSHES</b>	<b>111</b>

## HEMATOLOGY ..... 112-113



<b>BIOBLOOD DEVICES</b>	<b>112</b>
TYPESAFE™ in PVC	112
Drop slide system	112
<b>BREAKLOT STICK</b>	<b>112</b>
<b>BLOOD GROUPING STRIPS</b>	<b>112</b>
<b>SYRINGES FOR BLOOD COLLECTION</b>	<b>113</b>
<b>BUTTERFLY NEEDLE</b>	<b>113</b>
<b>96-WELL MICROTITER PLATES IN POLYSTYRENE</b>	<b>113</b>
<b>TOURNIQUETS</b>	<b>113</b>
<b>STERILE NEEDLE</b>	<b>113</b>
<b>SAFE TOUCH BUTTERFLY NEEDLE</b>	<b>113</b>

## CAT.NO. INDEX ..... 114-119



Search **CLEARLine**  
**certificates** of analysis on  
[www.biosigma.com/certificate](http://www.biosigma.com/certificate)

• Certificato di analisi • Certificate of analysis • Certificato di analisi • Certificate of analysis • Certificate of analysis •

LADR GmbH  
Medizinisches Versorgungszentrum Bremen  
Breitweg-Laborzentrale, 4. Umweltanalytik  
Lehring Dpt. Biol. Thomas Viegel

**Certificato di Analisi | Certificate of Analysis**

**CLEARLine®** Codice Prodotto / Catalog number: **CL2ARBEPS(S)**  
Numero di lotto / Lot number: **17P1005402**

• **DNA umano / Human DNA:**  
Metodo / Method: Polymerase Chain Reaction  
Limite / Limit: > 2 µg. meno di una cellula umana / less than one human cell

• **DNase:**  
Metodo / Method: Digestione DNA / DNA digestion  
Limite / Limit: Non rilevabile / not detectable (LOD 1.0 x 10<sup>4</sup> Kunitz-unit)

• **RNase:**  
Metodo / Method: Digestione RNA / RNA digestion  
Limite / Limit: Non rilevabile / not detectable (LOD 1.0 x 10<sup>4</sup> Kunitz-unit)

• **Inibizione PCR / PCR inhibition:**  
Metodo / Method: Polymerase Chain Reaction  
Limite / Limit: Meno di 10 target amplificati / Less than 10 targets amplified

• **Endotoxine / Endotoxin:**  
Metodo del test / Test method: Chetico turbidometric LAL test (Ph. Eur.) / Kinetico-turbidometric LAL test (Ph. Eur.)  
Limite / Limit: < 0,001 UE (EU, IU) / ml

• **ATP:**  
Metodo del test / Test method: Test di pre-sterilizzazione / Pre-sterilization test. (Schorlen test)  
Limite / Limit: < 5,5 x 10<sup>-7</sup> mg

I test del lotto sopra descritti hanno dimostrato la conformità ai limiti di rilevamento. Il lotto viene rilasciato per l'uso.  
Testing of the above described lot showed conformity within limits of detection. The lot is released for use.

2017-04-20 Data / Date **Bio1703-865** Numero di registrazione / Registration number **Dr. Biol. Thomas Viegel**

I risultati dei test si riferiscono esclusivamente agli articoli testati. Il certificato non deve essere copiato nemmeno parzialmente senza l'approvazione dei laboratori LADR GmbH.  
The test results refer exclusively to the items tested. The certificate must not be copied partially without the approval of LADR GmbH.

LADR GmbH Service Laborzentrale - 4. Umweltanalytik | Friedrich-Karl-Str. 22 | D-28229 Bremen  
Phone: +49 421 4307-900 | Fax: +49 421 4307-199 | E-Mail: [medlab@labozentrum-bremen.de](mailto:medlab@labozentrum-bremen.de)

• Certificato di analisi • Certificate of analysis • Certificato di analisi • Certificate of analysis • Certificate of analysis •



## CRYOWARE



For more details please visit:  
<http://www.biosigma.com/cryoware.html>

A complete line of cryogenic vials and boxes to store specimens at temperatures as LOW AS  $-196\text{ C}^{\circ}$  (vapor phase of liquid nitrogen).

Biosigma CryoGen<sup>®</sup> tubes are certified Human DNA, DNase/RNase/Pyrogen/ATP/PCR Inhibitors free, sterile SAL  $10^{-6}$  and IATA PI 650, with a unique and consecutive 1D barcode printed on the tubes' bodies.

The line also includes 2D CryoGen<sup>®</sup> tubes, in addition to 1D linear barcode, having a 2D data matrix barcode on the tubes' bottoms.

CryoGen<sup>®</sup> vials can be stored into Biosigma CryoGen<sup>®</sup> boxes, 25, 81 or 100 places, provided of 1D linear barcode printed on the box side or 2D CryoGen<sup>®</sup> boxes with also 2D matrix barcoded on boxes' bottoms.

Cryoboxes are made of polycarbonate to resist at temperatures as LOW AS  $-196\text{ C}^{\circ}$  (vapor phase of liquid nitrogen).

Autoclavable at  $120\text{ C}^{\circ}$  for 20 minutes.

Medical grade raw material certified USP Class VI, in accordance with United States Pharmacopeia and ISO 10993.

### **WARNING**

**Do not store CryoGen<sup>®</sup> tubes in liquid phase Nitrogen. Ingress of Nitrogen into the tube can occur by causing the tube to rupture when taken out of storage. May cause injury and loss of tube contents. Working Temperature: suitable for storage from general cold storage refrigeration ( $+4\text{ C}^{\circ}$ ) down to the vapor phase of liquid nitrogen.**

## 1D CRYOLINE

CryoGen® Tubes / 1D linear barcode



- ▶ Human DNA, DNase, RNase, Pyrogen, ATP, PCR inhibitors free certified\*
  - ▶ Sterile SAL 10<sup>-6</sup> \*
  - ▶ CE-IVD marked \*
  - ▶ Certified IATA PI 650
  - ▶ Manufactured in Clean Room Class ISO 7 (UNI EN ISO 14644-1). Class 10000 (US FED STD 209E)
  - ▶ Working Temperature: suitable for storage from general cold storage refrigeration (+4°C) down to the vapor phase of liquid nitrogen
  - ▶ Tubes in Polypropylene / Caps in Polyethylene and TPV
- \* Certificate of analysis, Certificate of validated Beta rays treatment and Declaration of conformity CE-IVD available for download on [www.biosigma.com](http://www.biosigma.com)

**CLEARLine®**  
"Be cool, be safe, be CLEARLine"



**Color coded** inserts are available to fit both internal and external caps for quick sample identification (see pag 24)

**Star shaped top cavity** is engineered for use with automatic decapping equipment

**Innovative internal and external screw caps** are produced from medical grade polyethylene (PE) and are comolded with a thermoplastic elastomer (TPV) to provide a 100% leak-proof seal

**Chemical resistant caps**

**Slim profile** external caps ensure better fit in standard racks and boxes

**Produced from medical grade raw materials** that will not discolor after re-sterilizing

Vials and caps are **autoclavable**

**Printed graduations** for accurate measurements

**Standard code 128 barcode** on each vial includes human readable characters printed in both left and right hand orientation for easy readability by all users.

**White writing surface** for specimen identification

**Chemical resistant polypropylene (PP)** vial

**Round bottom** or **self standing**

**Self-standing vials interlock** in workstations

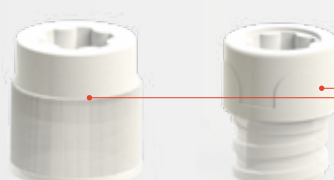

Our innovative screw caps **eliminate leakage and contamination**. Both internal and external screw caps are comolded with a thermoplastic elastomer (TPV) layer and are 95kPa certified to provide a 100% leak-proof seal. This proprietary molding process eliminates the risk of contamination associated with brands that use separate o-rings.





## CryoGen® Tubes / 1D linear barcode **EXTERNAL CAP Tubes**

**CLEARLine®**  
"Be cool, be safe, be CLEARLine"



### CryoGen Tubes External cap

Sterile, DNase, RNase, Human DNA, ATP, Pyrogen free

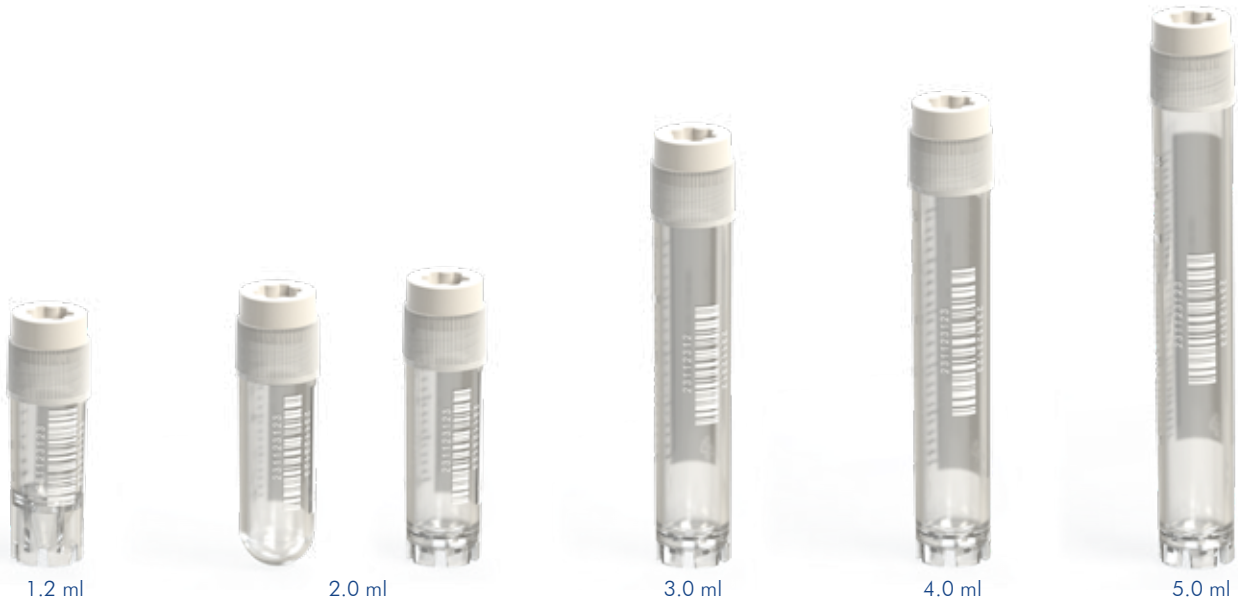

#### External cap - case / 500

CAT. NO.	Vol. (ml)	Height (cm)	Bottom style	Internal packaging	Sale unit
CL1ARBEPSTS	1.2	4.02	Self Standing	bag / 50	case / 500
CL2ARBEPSTS	2.0	4.56	Self Standing	bag / 50	case / 500
CL2AREPSTS	2.0	4.45	Round bottom	bag / 50	case / 500
CL3ARBEPSTS	3.0	6.92	Self Standing	bag / 50	case / 500
CL4ARBEPSTS	4.0	7.36	Self Standing	bag / 50	case / 500
CL5ARBEPSTS	5.0	8.76	Self Standing	bag / 50	case / 500

#### External cap - packaging in bulk

CAT. NO.	Vol. (ml)	Height (cm)	Bottom style	Internal packaging	Sale unit
CL1ARBEPSTS/B	1.2	4.02	Self Standing	bag / 50	carton / 4500
CL2ARBEPSTS/B	2.0	4.56	Self Standing	bag / 50	carton / 4000
CL2AREPSTS/B	2.0	4.45	Round bottom	bag / 50	carton / 4000
CL3ARBEPSTS/B	3.0	6.92	Self Standing	bag / 50	carton / 2500
CL4ARBEPSTS/B	4.0	7.36	Self Standing	bag / 50	carton / 2500
CL5ARBEPSTS/B	5.0	8.76	Self Standing	bag / 50	carton / 2000

6 different colors caps available. To order add ending as follows:  
/AZ (blue) /BI(white) /G(yellow) /RO(red) /V(green) /VI(violet)



### For automatic capper/decapper

Star shaped top cavity is engineered for use with automatic decapping equipment (see page 20)



### No contamination risk

Our innovative screw caps eliminate leakage and contamination. Both internal and external screw caps are co-molded with a thermoplastic elastomer (TPV) layer and are 95kPa certified to provide a 100% leak-proof seal. This proprietary molding process eliminates the risk of contamination associated with brands that use separate o-rings.



### Insert for color coding

Color coded inserts are available to fit both internal and external caps for quick sample identification (see page 24)

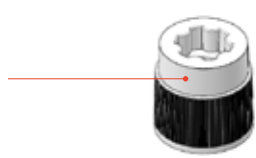

## Cryoboxes in polycarbonate



Boxes in polycarbonate for CryoGen® Tubes storage. Different models are available to accommodate either 25, 81 or 100 CryoGen® tubes. These durable cryogenic storage boxes are designed to be used at temperatures between -196°C and +121°C and are autoclavable at 120°C, for 20 minutes.

- ▶ For storing at temperatures as low as -196 °C (vapor phase of liquid nitrogen)
- ▶ Autoclavable at 121 °C for 20 minutes

- ▶ Numerical grid printed on the lid
- ▶ Frosted area on both lid and bottom for an easy writing
- ▶ Colored grid
- ▶ For storing at temperatures as low as -196 °C (vapor phase of liquid nitrogen)
- ▶ Autoclavable at 121 °C for 20 minutes
- ▶ Vial Picker: Removal of vials facilitated by a vial picker. Suitable for both internal and external Cryogen Tubes screw cap. Supplied with each pack of storage boxes
- ▶ In polycarbonate

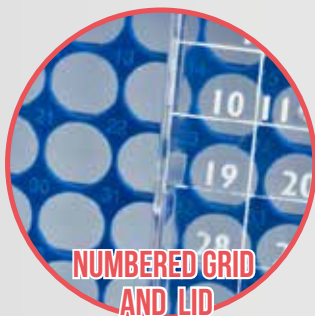

### CLEARLine® Accessories



25 Places

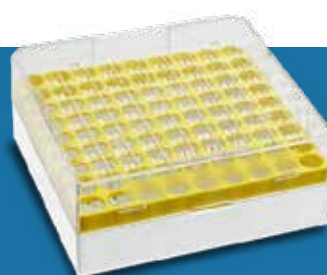

81 Places low

#### CryoGen® Box 25 pad printed grid lid for 1 - 2 ml tubes, external and internal cap

CAT. NO.	Grid Color	Dimensions (mm)	Internal packaging	Sale unit
BSM58025B/AZ	light blue	76x76x52	6 packs of 8 units	case / 48
BSM58025B/RO	red	76x76x52	6 packs of 8 units	case / 48
BSM58025B/V	green	76x76x52	6 packs of 8 units	case / 48
BSM58025B/G	yellow	76x76x52	6 packs of 8 units	case / 48

#### CryoGen® Box 81 LOW pad printed grid lid for 1 - 2 ml tubes, external and internal cap

CAT. NO.	Grid Color	Dimensions (mm)	Internal packaging	Sale unit
BSM58061B/AZ	light blue	132x132x52	8 packs of 5 units	case / 40
BSM58061B/RO	red	132x132x52	8 packs of 5 units	case / 40
BSM58061B/V	green	132x132x52	8 packs of 5 units	case / 40
BSM58061B/G	yellow	132x132x52	8 packs of 5 units	case / 40



81 Places high

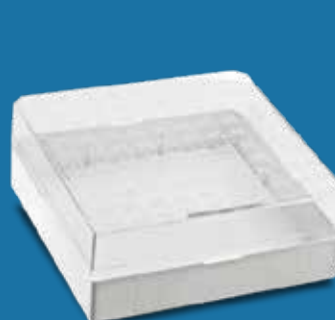

100 Places

#### CryoGen® Box 81 HIGH pad printed grid lid for 3 - 4 - 5 ml tubes external cap, and 5 ml internal cap

CAT. NO.	Grid Color	Dimensions (mm)	Internal packaging	Sale unit
BSM58071B/AZ	light blue	132x132x94	8 packs of 4 units	case / 32
BSM58071B/RO	red	132x132x94	8 packs of 4 units	case / 32
BSM58071B/V	green	132x132x94	8 packs of 4 units	case / 32
BSM58071B/G	yellow	132x132x94	8 packs of 4 units	case / 32

#### CryoGen® Box 100 pad printed grid lid for 1 - 2 ml tubes, internal cap

CAT. NO.	Color	Dimensions (mm)	Internal packaging	Sale unit
BSM58100/B	white	132x132x52	8 packs of 5 units	case / 40
BSM58100/AZ	light blue	132x132x52	8 packs of 5 units	case / 40
BSM58100/RO	red	132x132x52	8 packs of 5 units	case / 40
BSM58100/V	green	132x132x52	8 packs of 5 units	case / 40
BSM58100/G	yellow	132x132x52	8 packs of 5 units	case / 40

## 1D Cryoboxes in polycarbonate



- ▶ Linear Barcode 'code 128' lasered on the rack side with human reading decoding
- ▶ Numerical grid serigraphed both on lid and bottom for an easy positioning
- ▶ Frosted area on both lid and bottom for an easy writing
- ▶ Colored grid

- ▶ For storing at temperatures as low as -196 °C (vapor phase of liquid nitrogen)
- ▶ Autoclavable at 121 °C for 20 minutes
- ▶ Vial Picker: Removal of vials facilitated by a vial picker. Suitable for both internal and external Cryogen Tubes screw cap. Supplied with each pack of storage boxes
- ▶ In polycarbonate



### CLEARLine® Accessories



25 Places



81 Places low

#### CryoGen® Box 25 1D barcoded for 1 - 2 ml tubes, external and internal cap

CAT. NO.	Grid Color	Dimensions (mm)	Internal packaging	Sale unit
BSM58025B1D/AZ	light blue	76x76x52	6 packs of 8 units	case / 48
BSM58025B1D/RO	red	76x76x52	6 packs of 8 units	case / 48
BSM58025B1D/V	green	76x76x52	6 packs of 8 units	case / 48
BSM58025B1D/G	yellow	76x76x52	6 packs of 8 units	case / 48

#### CryoGen® Box 81 LOW 1D barcoded for 1 - 2 ml tubes, external and internal cap

CAT. NO.	Grid Color	Dimensions (mm)	Internal packaging	Sale unit
BSM58061B1D/AZ	light blue	132x132x52	8 packs of 5 units	case / 40
BSM58061B1D/RO	red	132x132x52	8 packs of 5 units	case / 40
BSM58061B1D/V	green	132x132x52	8 packs of 5 units	case / 40
BSM58061B1D/G	yellow	132x132x52	8 packs of 5 units	case / 40



81 Places high

#### CryoGen® Box 81 HIGH 1D barcoded for 3 - 4 - 5 ml tubes external cap and 5 ml internal cap

CAT. NO.	Grid Color	Dimensions (mm)	Internal packaging	Sale unit
BSM58071B1D/AZ	light blue	132x132x94	8 packs of 4 units	case/ 32
BSM58071B1D/RO	red	132x132x94	8 packs of 4 units	case/ 32
BSM58071B1D/V	green	132x132x94	8 packs of 4 units	case/ 32
BSM58071B1D/G	yellow	132x132x94	8 packs of 4 units	case/ 32



100 Places

#### CryoGen® Box 100 1D barcoded for 1 - 2 ml tubes, internal cap

CAT. NO.	Color	Dimensions (mm)	Internal packaging	Sale unit
BSM581001D/B	white	132x132x52	8 packs of 5 units	case / 40

## 2D CRYOLINE

CryoGen® Tubes / 2D barcode



**CLEARLine®**  
"Be cool, be safe, be CLEARLine"



**Color coded inserts** are available to fit both internal and external caps for quick sample identification (see pag 24)

**Innovative internal and external screw caps** to provide a 100% leak-proof seal

**Produced from medical grade raw materials** that will not discolor after re-sterilizing

**Printed graduations** for accurate measurements

**White writing surface** for specimen identification

**Datamatrix Code inserted in the bottom**, sequential and corresponding to the "Code 128" on the tube body

The 2D code is automatically generated from the linear barcode during the manufacturing process  
Permanent laser etching system

Strict quality control, every tube is checked to ensure they meet our exacting standards of reading

The insert is secured in place by the use of ultrasound to weld it into place

**Star shaped top cavity** is engineered for use with automatic decapping equipment

**Slim profile** external caps ensure better fit in standard racks and boxes

Vials and caps are **autoclavable**

**Standard code 128 barcode** on each vial includes human readable characters printed in both left and right hand orientation for easy readability by all users.

**Locking Base** features prevents tubes rotating within the rack/workstation during capping and decapping.

The base of the tube is provided with **channels of evacuation** of the cryogenic liquid that could possibly be trapped between the base of the tube and the 2D pad.

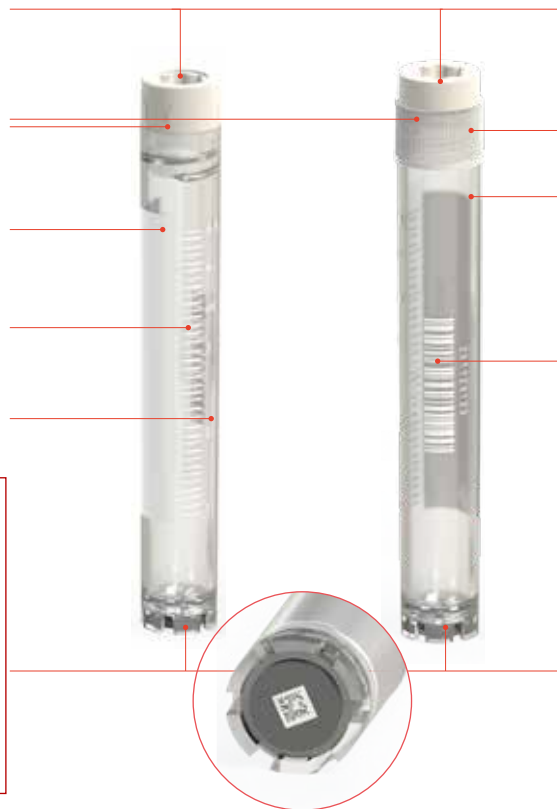

- ▶ Human DNA, DNase, RNase, Pyrogen, ATP, PCR inhibitors free certified\*
- ▶ Sterile SAL 10<sup>-6</sup> \*
- ▶ CE-IVD marked \*
- ▶ Certified IATA PI 650

- ▶ Manufactured in Clean Room Class 10000 ISO 7
- ▶ Working Temperature: suitable for storage from general cold storage refrigeration (+4°C) down to the vapor phase of liquid nitrogen
- ▶ Tubes in Polypropylene / Caps in Polyethylene and TPV

\* Certificate of analysis, Certificate of validated Beta rays treatment and Declaration of conformity CE-IVD available for download on [www.biosigma.com](http://www.biosigma.com)

### CryoGen Tubes 2D Internal cap

Sterile, DNase, RNase, Human DNA, ATP, Pyrogen free



2.0 ml

5.0 ml

### CryoGen Tubes 2D External cap

Sterile, DNase, RNase, Human DNA, ATP, Pyrogen free



2.0 ml

5.0 ml

#### Internal cap

CAT. NO.	Vol. (ml)	Height (cm)	Bottom style	Internal packaging	Sale unit
CL2ARBIPS2D	2.0	4.82	Self Standing	bag / 50	case / 500
CL2ARBIPS2D/B	2.0	4.82	Self Standing	bag / 50	carton / 4000
CL5ARBIPS2D	5.0	9.03	Self Standing	bag / 50	case / 500
CL5ARBIPS2D/B	5.0	9.03	Self Standing	bag / 50	carton / 2000

#### External cap

CAT. NO.	Vol. (ml)	Height (cm)	Bottom style	Internal packaging	Sale unit
CL2ARBEPS2D	2.0	4.56	Self Standing	bag / 50	case / 500
CL2ARBEPS2D/B	2.0	4.56	Self Standing	bag / 50	carton / 4000
CL5ARBEPS2D	5.0	8.76	Self Standing	bag / 50	case / 500
CL5ARBEPS2D/B	5.0	8.76	Self Standing	bag / 50	carton / 2000

YouTube



<https://bit.ly/2JELQ3x>



## 2D Cryoboxes in polycarbonate 81 and 100 places



- ▶ Automatic identification of the box and of its positioning through 2D datamatrix code, on the box bottom
- ▶ Barcode "code 128" lasered on rack side.
- ▶ Numerical grid on lid
- ▶ Frosted writing area
- ▶ Colored grid
- ▶ For storing at temperatures as low as -196 °C (vapor phase of liquid nitrogen)
- ▶ Autoclavable at 121 °C for 20 minutes
- ▶ Vial Picker supplied with each inner pack
- ▶ White bottom
- ▶ In polycarbonate



**CLEARLine®**  
Accessories



81 Places 2D low



81 Places 2D high

### Box 81 LOW pad printed grid lid 2D for 2 ml tubes

CAT. NO.	Grid Color	Dimensions (mm)	Internal packaging	Sale unit
BSM580612D/AZ	light blue	132x132x52	8 packs of 5 units	case / 40
BSM580612D/RO	red	132x132x52	8 packs of 5 units	case / 40
BSM580612D/V	green	132x132x52	8 packs of 5 units	case / 40
BSM580612D/G	yellow	132x132x52	8 packs of 5 units	case / 40

### Box 81 HIGH pad printed grid lid 2D for 5 ml tubes

CAT. NO.	Grid Color	Dimensions (mm)	Internal packaging	Sale unit
BSM580712D/AZ	light blue	132x132x94	8 packs of 4 units	case / 32
BSM580712D/RO	red	132x132x94	8 packs of 4 units	case / 32
BSM580712D/V	green	132x132x94	8 packs of 4 units	case / 32
BSM580712D/G	yellow	132x132x94	8 packs of 4 units	case / 32



100 Places 2D low



100 Places 2D high

### Box 100 LOW pad printed grid lid 2D for 2 ml tubes, internal cap

CAT. NO.	Color	Dimensions (mm)	Internal packaging	Sale unit
BSM581002D/B	white	132x132x52	8 packs of 5 units	case / 40

### Box 100 HIGH pad printed grid lid 2D for 5 ml tubes, internal cap

CAT. NO.	Color	Dimensions (mm)	Internal packaging	Sale unit
BSM581052D/B	white	132x132x94	8 packs of 4 units	case / 32

## 48 Places SBS rack for 2 and 5 ml 2D CryoGen® tubes



Storage cryo rack 48 places with a footprint that corresponds to ANSI-standard

- ▶ Stackable
- ▶ Rack bottom with scanning windows for the Datamatrix of the contained cryotubes
- ▶ In Polypropylene
- ▶ Linear barcode
- ▶ Alphanumeric bottom
- ▶ Available for both 2 and 5 ml 2D CryoGen® Tubes
- ▶ Suitable for automatic capper-decapper
- ▶ Suitable for multiscanner



**SCREWING WITH A SINGLE HAND**



**FOR MULTISCANNER**



**ENGRAVED LID**



**SCANNING WINDOW AND 2D DATAMATRIX ON THE BOTTOM**



**LINEAR BARCODE ON RACK SIDE**



**ENGRAVED LETTERS**

**ALPHANUMERIC BOTTOM**

**SERIGRAPHED LETTERS AND NUMBERS**



**LINEAR BARCODE ON RACK SIDE**

**SERIGRAPHED NUMBERS**

**ALPHANUMERIC BOTTOM**

**ENGRAVED LETTERS**

**CLEARLine®**  
Accessories



**48 PLACE ANSI/SLAS Racks**  
(rakcs only)

CAT. NO.	Description	Sale unit
BSM58048H	Rack 48 places for 5 ml int/ext CryoGen® tubes 2D	10
BSM58048L	Rack 48 places for 2 ml int/ext CryoGen® tubes 2D	20



**48 PLACE ANSI/SLAS Racks**  
Pre-Racked with Tubes

CAT. NO.	Description	Tubes	Sale unit
BSM58048HI	Rack 48 places filled with 5 ml internal CryoGen® tubes 2D	5 ml	10
BSM58048HE	Rack 48 places filled with 5 ml external CryoGen® tubes 2D	5 ml	10
BSM58048LI	Rack 48 places filled with 2 ml internal CryoGen® tubes 2D	2 ml	20
BSM58048LE	Rack 48 places filled with 2 ml external CryoGen® tubes 2D	2 ml	20

## SINGLE SCREW DECAPPERS for CryoGen® Tubes

### Electronic Decapper/Recapper and Tube Picker

Versatile and easy to use tool specifically designed to decap and recap CryoGen® Tubes 2D barcode tubes and enable the user to individually pick and place tubes from CryoGen® Boxes 2D and ANSI/SLAS racks

#### FEATURES

- ▶ Rapid decapping and capping
- ▶ Very simple to use
- ▶ USB Battery charger
- ▶ Closing intensity adjustment
- ▶ Light weight

#### Package Contents

- ▶ Electronic Decapper/Recapper
- ▶ USB cable
- ▶ USB charger



**CLEARLine®**  
Accessories



CAT. NO.	Description	Internal packaging	Sale unit
BSM580481	Single screw decapper	1	1

## Fully automatic capper / decapper for 48 places SBS ANSI/SLAS rack & 2ml CryoGen® Tubes

**CLEARLine®**  
Accessories



### Digital automatic Decapper/Recapper

The new Biosigma decapper provides a simple decapping and capping solution for CryoGen® Tubes 2D in a SBS ANSI/SLAS format rack 48 places. It offers a time saving solution that reduces the risks of repetitive strain injuries and potential sample cross contamination. Decapping and capping can be performed on 2ml CryoGen® Tubes.

#### FEATURES

- ▶ Rapid decapping and capping
- ▶ Very simple to use
- ▶ Reduce risk of cross contamination
- ▶ Reduce risk of repetitive strain injury
- ▶ Recapping process ensures that tubes are tightly capped-no loose caps after operation

#### Simple and Direct

Rather than using messy mechanical means the decapper digitally measures the force applied to cap each tube. This means it is quieter than other 48 well decappers and also does not have clutches that can wear out.

#### Easy to Use

With no extra unneeded controls, there are two buttons. One to cap and one to decap; the decapper recognises when a rack has caps and illuminates the decap button and vice versa.

CAT. NO.	Description	Internal packaging	Sale unit
BSM58048	Fully automatic capper / decapper	1	1

## SBS 2D Coded storage tubes 450 and 980 µl

- ▶ Made in low-retention virgin polypropylene
- ▶ Available in 450 µl and 980 µl
- ▶ In SBS racks or bulk
- ▶ With screw caps or cap mats
- ▶ Non-sterile or Sterile
- ▶ Certified human DNA, RNase, DNase and endotoxin-free
- ▶ Manufactured in Clean Room ISO 8 conditions
- ▶ Full traceability system :
  - 2D DataMatrix barcode under each tube
  - 2D DataMatrix & Standard barcode on each rack



### Tubes

- ▶ In low-retention virgin polypropylene
- ▶ Natural colour, excellent transparency
- ▶ 2D DataMatrix Barcode laser engraved under each tube, readable by all scanner brands
- ▶ Skirted round bottom
- ▶ Internal thread for screw caps
- ▶ For use down to -196°C with PP screw caps, -80°C with TPE cap mats (push caps)

### Racks

- ▶ Lockable lid
- ▶ Standard barcode on the side of each rack
- ▶ Corresponding 2D DataMatrix barcode under each rack
- ▶ Centre-to-centre distance between racked tubes: 9.0 mm
- ▶ International ANSI-SBS format



Rack base : 2D Datamatrix barcode under each tube and the rack

Non sterile CAT. NO.	Sterile CAT. NO.	Tubes in rack Description	Sale unit
4949038	4949039	96-tube rack, 450µl, without caps	10 racks
4949040	4949041	96-tube rack, 450µl, with blue screw caps	
4949046	4949047	96-tube rack, 980µl, without caps	
4949048	4949199	96-tube rack, 980µl, with blue screw caps	
4949054	-	Empty barcoded rack for 450µl tubes	
4949055	-	Empty barcoded rack for 980µl tubes	

Non sterile CAT. NO.	Sterile CAT. NO.	Tubes in bulk Description	Sale unit
4949042	4949043	96-tube bag, 450µl, without caps	10 bags
4949044	4949045	96-tube bag, 450µl, with blue screw caps	
4949050	4949051	96-tube bag, 980µl, without caps	
4949052	4949053	96-tube bag, 980µl, with blue screw caps	



Standard barcode on the side of each rack

Tube	Rack height w/o lid (mm)	Rack heightw/ lid (mm)
450 µl	33.5	36.2
980 µl	51.5	54.2

Tube	Gross volume (µl)	Working volume with screw caps (µl)	Working volume with push caps (µl)
450 µl	660	450	540
980 µl	1230	980	1070

Tube	External diameter (mm)	Tube height w/o cap (mm)	Tube height w/ screw cap (mm)	Tube height w/ cap mat (mm)
450 µl	8.4	27.0	33.4	28.0
980 µl	8.4	45.0	51.4	46.0

## SBS Caps

### Screw Caps

- ▶ In low-retention virgin polypropylene
- ▶ O-Ring injection molded
- ▶ Compatible for automated decapping
- ▶ For use down to -196°C (over LN2)
- ▶ Manufactured under ISO 8 Clean Room conditions
- ▶ Certified free from :
  - human DNA, RNase, DNase & endotoxins



### Cap Mats

- ▶ In thermoplastic elastomer (TPE)
- ▶ Efficient sealing of internal thread tubes
- ▶ Seal 96 tubes at once
- ▶ For use down to -80°C
- ▶ Manufactured under ISO 8 Clean Room conditions
- ▶ Free of human DNA, RNase-DNase and endotoxins



Description	White	Black	Blue	Red	Green	Yellow	Orange	Assorted	Sale unit
Screw Caps	4949056	4949057	4949058	4949059	4949060	4949061	4949062	4949063	960
Cap Mats	4949064	4949065	4949066	4949067	4949068	4949069	4949070	4949071	960

## Cappers - Decappers

- ▶ For screw caps or cap mats
- ▶ Available as automatic, semi-automatic or manual device

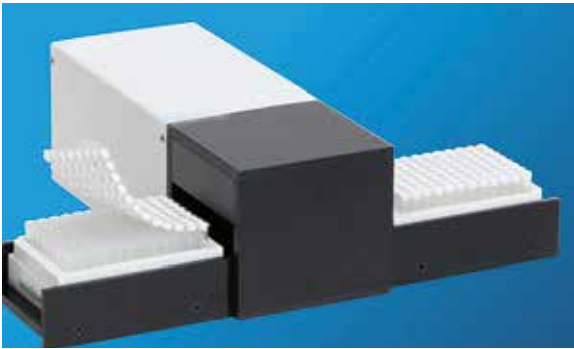

4949033



4949035



4949036

### Cappers-Decapper For Internal thread cap in PP

CAT.NO.	Model	Sale unit
4949035	Capper-Decapper automatic 96 channels for screw cap	1
4949036	Capper-Decapper manual single tube for screw cap	1

### Cappers-Decapper For Cap mats

CAT.NO.	Model	Sale unit
4949032	Capper-Decapper manual single tube and 8 channel for 96 cap mats	1
4949033	Capper-Decapper semi-automatic for 96 cap mats	1
4949072	Decapper manual single-tube for 96 cap mats	1

## Scanners

- ▶ Scan, track and maintain your samples
- ▶ Scans 2D datamatrix tubes in SBS and cryoracks format
- ▶ Five different masks, nearly any combination of racks is possible and up to four racks can be scanned at the same time.
- ▶ Ready to use only a few minutes
- ▶ All the exported information can be integrated into systems such as: Oracle, SQL, MySQL, Postgres, HSQL and many others.
- ▶ Scanned images can also be saved

- ▶ Can also be used with our Linear Barcode Reader so the barcode on the side of the rack can be scanned as well as the 2D codes on the tubes
- ▶ DataPaq™ software displays the results of the scan
- ▶ Special coating that eliminates the condensation and ensures uninterrupted scanning.

### Multiscanner

CAT. NO.	Description	Sale unit
779912	DataPaq High Speed Multiple Rack Scanner; includes one Mask from the ZTS-MXX Mask range	1
779913	DataPaq High Speed Multiple Rack Scanner with Cryoprotection; includes one Mask from the ZTS-MXX Mask range	1
779940	A4 1D Rack Scanner Mark 2	1
ZTS-1DR2-A4-BRK	Extra Bracket for A4 1D Rack Scanner Mark 2	1
779916	A4 Mask for 3 * SBS Racks	1
779917	A4 Mask for 2 * Cryoracks	1
779918	A4 Mask for 1 * SBS Rack and 1 * Cryorack	1
779919	A4 Mask for 1 * Cryorack	1
779920	A4 Mask for 4 * SBS Rack	1



MULTISCANNER

### Single Tube Reader 1D/2D

- ▶ Features the industry's fastest 1D/2D-imaging technology for highly responsive, reliable scanning
- ▶ Unique, ergonomic styling maximizes comfort and saves countertop space
- ▶ Large LED indicator provides effective visual operational feedback
- ▶ Easy plug&play installation on your PC
- ▶ USB cable
- ▶ Available with USB cable or Wireless with charge base



CAT. NO.	Description	Sale unit
SG20THP-USB001	Scanner USB + USB cable	1
SG20BHP-USB002	Scanner wireless + base station BT + USB cable	1



## A sample management system optimised for your laboratory's needs

- ▶ Samples is a laboratory sample management tool designed to keep your sample storage inventory organised.
- ▶ Samples software includes a host of features designed to streamline your sample storage workflows and makes adding and searching sample information quick and simple.
- ▶ Its intuitive import tools allow integration with existing sample databases, while its range of sample entry options and fully editable set-up parameters means the system can be optimised for your laboratory or storage facility.
- ▶ We can even add custom features, developed by our programmers to your specifications, to ensure Samples provides the exact solution for your inventory management requirements.



Inventory View and Container View

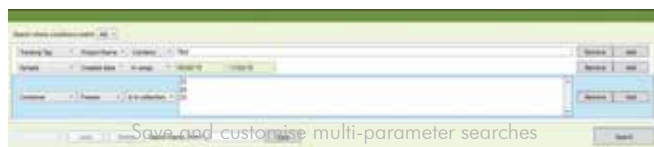

### EASY DATA INPUT

In addition to manual entry of individual samples using the intuitive user interface, Samples lets you easily import sample data from existing records in Excel spreadsheet or text file format. Our Import Wizard ensures your imported data is compatible, meaning adding legacy data couldn't be simpler. You can scan in samples quickly and easily using Ziath's DataPac™ barcode readers, and efficiently register any changes to your 2D storage racks and boxes.



### CUSTOM DESCRIPTORS

Samples' customisable Tracking Tags and Sample Types allow you to associate fully-searchable data with your samples. Create an unlimited number of Tracking Tags to describe your samples using a variety of descriptor formats including free text, quantities, dates and even links to documents such as safety or regulatory datasheets. Our Sample Types labelling feature allows differentiation between, for example, samples in multiple laboratories, and each Sample Type can have its own set of Tracking Tags.

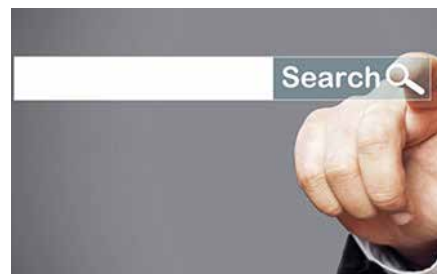

### POWERFUL SEARCHING

Samples lets you easily switch between viewing graphical displays of container layouts or a list of all containers and samples. Our multi-parameter search tool allows you to combine search terms to locate specific samples using Tracking Tags and Sample Type entries, keywords, location or date records. You can even save regularly-used searches and customise them for future use. And with our archive function, you will never lose access to historical data, even when a container has been permanently removed from storage.

#### Samples software

CAT. NO.	Description	Sale unit
779944	Samples Software Fixed License (Single PC with multi-user)	1
ZTD-SPLS-FLT1	First Floating License (Server licence. Necessary for connect other clients with floating licence)	1
ZTD-SPLS-FLT	Samples Software Additional Floating License for one single clients	1



## ACCESSORIES

### Writing cap disks

- ▶ 6 colours available
- ▶ In medical grade raw material
- ▶ Wide surface for easy writing
- ▶ For both internal and external cap



**CLEARLine®**  
Accessories



Cap Disk for internal and external Cryogen Tubes screw caps.

CAT. NO.	Color	Internal packaging	Sale unit
CRY910TS/AZ	blue	1 / bag	bag / 1000
CRY910TS/RO	red	1 / bag	bag / 1000
CRY910TS/V	green	1 / bag	bag / 1000
CRY910TS/G	yellow	1 / bag	bag / 1000
CRY910TS/VI	violet	1 / bag	bag / 1000
CRY910TS/BI	white	1 / bag	bag / 1000

### Workstation for CryoGen® Tubes



Workstation for CryoGen® tubes, 40 holes, in polycarbonate, available in 3 colors, autoclavable. Useful for screwing and unscrewing the tube directly on the bench with a single hand, avoiding possible contamination.

**CLEARLine®**  
Accessories

- ▶ In polycarbonate
- ▶ 40 positions
- ▶ 3 colours available



Workstation for CryoGen® tubes, 40 holes

CAT. NO.	Color	Dimensions (mm)	Sale unit
BSM5810/AZ	blue	L 21.5 P 10.0 H 2.50	units / 5
BSM5810/RO	red	L 21.5 P 10.0 H 2.50	units / 5
BSM5810/V	green	L 21.5 P 10.0 H 2.50	units / 5

### Cryo Markers

- ▶ 4 colours available
- ▶ Specially for writing on cryotubes, cryoboxes and supports for cryogenics
- ▶ Blue, red and black with extra-fine tip
- ▶ Green with standard tip



CAT. NO.	Description	Sale unit
028123	Pack of 4 cryo markers assorted colours (green, blue, red, black)	4
028124	Pack of 4 cryo markers black colour	4

### Vial Picker for CryoGen® Tubes



- ▶ For an easy vial removal after freezing
- ▶ For both internal and external cap
- ▶ Supplied with cryoboxes inner packs

**CLEARLine®**  
Accessories



CAT. NO.	Grid Color	Internal packaging	Sale unit
CRY920TS	blue	bag/100	case / 600

## Cryoboxes in polypropylene

The specialty: boxes adjustable in height. The red cryo box shows the fixed position of 75 mm. The blue cryo box shows the variable lid position (rotated 90°) with the variable height from 50 mm to 75 mm.

- ▶ Polypropylene
- ▶ Dimensions: 133 x 133 mm, adjustable height: 50 mm or 75 mm
- ▶ Numerical coding
- ▶ Drain hole
- ▶ Autoclavable
- ▶ Resistant to temperatures of -90°C to +121°C
- ▶ Stackable

### Variable height polypropylene Cryo Boxes

Capacity	6 x 6	7 x 7	8 x 8	9 x 9	10 x 10
Tubes (mm)	19	17	15	13	11,5
neutral	030131	030138	750207	750214	750221
yellow	030132	030139	750208	750215	750222
red	030133	750202	750209	750216	750223
green	030134	750203	750210	750217	750224
blue	030135	750204	750211	750218	750225
black	030136	750205	750212	750219	750226
assorted	030137	750206	750213	750220	750227
Sale unit	5	5	5	5	5



## Cardboard Cryoboxes

- ▶ Supplied with the divider
- ▶ Dimensions: 133 x 133 x 52 mm
- ▶ Hold 0,5/1/ 2ml microtubes and 1/2 ml ClearLine® cyrotubes internal thread only (81 places boxes only)
- ▶ Chemically resistant to alcohols and mild organic solvent
- ▶ Temperature range : stable from -196 to 121 °C
- ▶ Suitable for liquid nitrogen storage



### ClearLine white coated cardboard freezer boxes

CAT. NO.	Color	Lid with writing area	Height (mm)	Grid	Sale unit
010161CL	white	X	52	81	1
010162CL	white	X	52	100	1
010183CL	white		52	81	1
010184CL	white		52	100	1

- ▶ White or coloured hydrophobic cardboard
- ▶ With labelling area on the lid
- ▶ Supplied with grids
- ▶ Mixed: pink, yellow, green, blue, turquoise
- ▶ Dimensions: 133 x 133 mm



### White or coloured cardboard cryoboxes with writing area

CAT. NO.	Color	Height (mm)	Grid	Sale unit
010163	white	75	81	1
010164	white	75	100	1
010179	assorted	50	81	5
010181	assorted	50	100	5

- ▶ Covered in a watertight plastic film
- ▶ Grids assembled in the box
- ▶ For freezing up to -196 °C
- ▶ Colour white
- ▶ Dimensions 133x133 (mm)

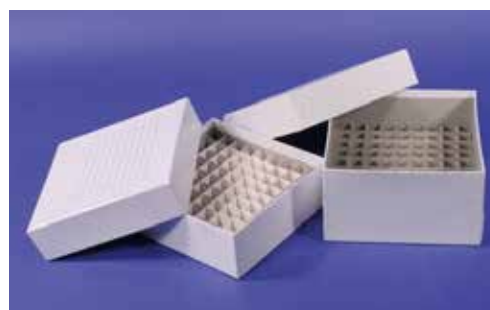

### Laminated cardboard boxes

CAT. NO.	Color	Height (mm)	Grid	Sale unit
010185	white	76	81	1
010186	white	76	100	1



## Support rod for canisters

- ▶ Aluminium rod designed to contain 3 to 6 cryotubes depending on their height. Length: 28 cm.



CAT. NO.	Description	Sale unit
055030	Support rod	50

## Cryoflex sheath

- ▶ Sheath for cryotubes, to be soldered to avoid any liquid nitrogen accidentally getting into the tube during total immersion in liquid nitrogen, preventing tube explosion. Length: 50 cm.



CAT. NO.	Description	Sale unit
055029	Cryoflex sheath	15

## Cryogenic gloves

Protect yourself from extreme temperatures. Gloves made for very high or low temperatures, with an outer layer made of nylon and an interior made of a cotton - polyester complex protected by a polyfine film.

- ▶ Soft, comfortable, warm, even after prolonged exposure to cold
- ▶ Machine washable and dryable

5 finger glove in 4 lengths:

- ▶ Wrist: 30 cm
- ▶ Mid-forearm: 38 cm
- ▶ Elbow: 50 cm
- ▶ Shoulder: 68 cm

NB: Never immerse the glove directly in nitrogen liquid.

Characteristics of the standard model:

- ▶ Freezer at very low temperatures
- ▶ Cold room
- ▶ Dry ice handling

Characteristics of the impervious model:

- ▶ Applications in a liquid nitrogen atmosphere or environment
- ▶ Coolant bars
- ▶ Cryogenic grinding



### STANDARD MODEL

### IMPERVIUS MODEL

	SMALL (S)	MEDIUM (M)	LARGE (L)	EXTRA LARGE (XL)	SMALL (S)	MEDIUM (M)	LARGE (L)	EXTRA LARGE (XL)	Sale unit
5 fingers 30 cm	035501	035502	035503	035504	035517	035518	035519	035520	1
5 fingers 38 cm	035505	035506	035507	035508	035521	035522	035523	035524	1
5 fingers 50 cm	035509	035510	035511	035512	035525	035526	035527	035528	1
5 fingers 68 cm	035513	035514	035515	035516	035529	035530	035531	035532	1

- ▶ For use of material stored in liquid nitrogen or at low temperatures
- ▶ Very good insulation, thinner gloves offering excellent dexterity
- ▶ Synthetic fibre for improved flexibility
- ▶ Water resistant
- ▶ Coating "waterproof"
- ▶ With suspension ring
- ▶ EC marking

### Cold protection gloves

	Gloves L. 37 cm	Gloves L. 50 cm	Gloves L. 60 cm	Sale unit
SMALL (S)	446658	446662	446670	1
MEDIUM (M)	446659	446663	446671	1
LARGE (L)	446660	446664	446672	1
EXTRA LARGE (XL)	446661	446665	446673	1



## COOLING CONTAINERS

### CoolCell containers

- ▶ CoolCell LX controlled-rate alcohol-free cell freezing container provides a highly reproducible -1°C/minute freezing rate when placed in a -80°C freezer.
- ▶ No alcohol or fluids required.
- ▶ The insulative outer housing and thermo-conductive solid state core ensure consistent heat removal to all vials throughout the freezing period.
- ▶ CoolCell containers are unbreakable, open easily when frozen, and are not cold to the touch when frozen - no "frosty" fingers.
- ▶ Numbered vial wells ensure an easy sample identification.
- ▶ Beveled junction between base and lid and exposed vial tops in the base allow for quick and safe removal of frozen vials so they can be placed into long-term storage.
- ▶ Holds 12 or 15 vials.
- ▶ Proven for use with stem cells, primary cells and cell lines.

CAT. NO.	Color	Tubes No.	Sale unit
830159	Purple	12 x 2ml	1
830105	Green	12 x 2ml	1
830106	Orange	12 x 2ml	1
830107	Pink	12 x 2ml	1
830108	Purple	15 x 5ml	1



### Cryocooler

CRYOCOOLER suitable for 18 x 1-2ml tubes ø x h: 117 x 86 mm

- ▶ Container for cryopreservation and recovery, suitable for 18 x 1-2ml tubes
- ▶ Requires Isopropyl alcohol
- ▶ 1°C/min cooling rate
- ▶ ø x h: 117 x 86 mm
- ▶ Screw cap

CAT. NO.	Description	Dimensions ø x h mm	Sale unit
913081	Cryo Cooler	117 x 86	1



### Freezing Rack

- ▶ Polycarbonate case filled with a non-toxic insulating gel
- ▶ To protect the reagents contained in

CAT. NO.	Body Color	Gel on the cover	Dim. (mm)	Capacity of Cryotube 1/2 ml, or Microtube 1.5/2 ml	Temperature/ Time	Sale unit
092391	Red	No	147 x 100 x 100	12	0 °C / 60 min.	1
092392	Yellow	No	147 x 100 x 100	12	-20 °C / 60 min.	1
092393	White	No	147 x 100 x 100	12	-70 °C / 45 min.	1
913077	Red	Yes	240 x 160 x 146	32	0 °C / 60 min.	1
913078	Yellow	Yes	240 x 160 x 146	32	-20 °C / 50 min.	1
913082	Yellow	Yes	240 x 160 x 146	1 PCR plate 96 tubes of 0.2 ml singles or strip	-20 °C / 60 min.	1



## Medical Grade Raw Materials

The quality of substances for pharmaceutical/medical, as a guarantee for their safe use and effectiveness must be evaluated according to standards, or specifics, continuously updated against the scientific-technological progress, any emerging problems and regulatory development. This implies a constant and dynamic review of the Texts that make up these rules and their subsequent publication in the "reference pharmacopoeia".

### TUBE : POLYPROPYLENE

### BI-INJECTED CAP : POLYETHYLENE +THERMOPLASTIC VULCANIZATE

#### STATEMENT ON COMPLIANCE TO REGULATIONS ON MEDICAL USE

The raw materials used to manufacture Biosigma's Cryogen Tubes fulfill the requirements on materials used for articles or components of articles intended for medical use as described in:

Council of Europe: European Pharmacopoeia, 7th edition (2011), and supplement 7.5 (07/2012)  
Monograph 3.2.2. Plastic containers and closures for pharmaceutical use

USA: The product has passed the United States Pharmacopoeia testing including Class VI tests and has been assigned a FDA Drug Master File.

Additional information: Material has successfully passed the biological tests according to ISO 10993 - external communicating devices for indirect blood contact for a prolonged period.

#### What is ISO 10993

European standard for biological evaluation of medical devices. Comparable to the USP, however, more elaborate (more categories and more tests). The material used for our CryoGen tubes are tested for the production of external communication devices for use during an extended period of time (min 1 day - max 30 days) for indirect contact with the path of the blood (for example, the plastic to produce a catheter tube).

#### EXECUTED TESTS:

- ▶ Cytotoxicity
- ▶ Sensitization
- ▶ Intracutaneous reactivity (irritation)
- ▶ Systemic toxicity
- ▶ Haemocompatibility

EP = European Pharmacopoeia is a legislative text which includes chapters and monographs to be followed in the production, preparation and marketing of products for pharmaceutical / medical applications.

#### What is meant by "conforms to USP Class VI"

- ▶ The United States Pharmacopoeia (USP) sets standards to ensure the quality of medicines and other technologies for health care.
- ▶ Among these standards, there are those related to the Biological Reactivity tests for "elastomers, plastics and other polymeric material with which the patient may, directly or indirectly come into contact", defining a division into six classes.
- ▶ The Class VI is more rigid class and is the most widely used and accepted by the industry of medical products.
- ▶ Depending on the outcome of the analysis, the material can be used or not used for the production of medical devices.

Not required in Europe, however the majority of customers appreciate the USP approval.

#### What is DMF = Drug Master File

It's a technical file that is sent from the manufacturer of the product to the FDA (U.S.) in which are described:

- ▶ Production processes
- ▶ Commitments by the Director of the plants
- ▶ Product specifications (including formulation)
- ▶ Quality System
- ▶ Results of the USP tests
- ▶ List of authorized persons

Once approved, the FDA issues a number of DMF, with which it is registered in the database.

A DMF ensures consistency in formulas and production procedures.

#### Other Compliance

- ▶ REACH-Restrictions on the manufacturing, placing on the market and use of certain dangerous substances, mixtures and articles: ES.: phthalates, Low weight moleculars (known as DEHP, DBP, and BBP DIBP) are classified as toxic for breeding based on animal studies and are regulated in their use and included in the annex XIV of the REACH Regulation as "Substances of Very High Concern" (SVHC) and subject to authorization.
- ▶ CONEG (packaging and packaging waste - PPW) - Sum of Cd, Cr, Hg and Pb <100 ppm.
- ▶ Directive 2000/53/EC (ELV) - Cr (VI), Hg and Pb <0.1% by weight, Cd <0.01% by weight.
- ▶ Directive 2011/65/EU (Restriction of use of certain hazardous substances in electrical and electronic equipment and machinery - ROHS- Cr (VI), Hg, Pb, PBB and PBDE <0.1% by weight, Cd <0.01 % by weight.
- ▶ Directive 2002/96/EC (Waste Electrical and Electronic Equipment - WEEE) - Annex II - No ingredients are used requires a selective waste treatment (As, Hg, PCB, PCT, CFC, HCFC, HFC, brominated FR).
- ▶ Regulation 1005/2009/EC (Substances that deplete the ozone layer) - Prohibition of CFC's, HCFC's, Halons, CCl4, Trichloroethane, HBFC's.
- ▶ U.S. Clean Air Act, Title VI, classes I and II (EPA Final Rule, Federal Register 8136, 11.02.1993) on substances that deplete the ozone layer.
- ▶ Regulation 850/2004/EC on persistent organic pollutants (POPs).
- ▶ Directives 2003/89/EC, 2006/142/EC, 2007/68/EC, amending Directive 2000/13/EC - Annex IIIa (allergens).

The materials are also declared free of animal products, without a potential risk of TSE. BSE is chronic neurological disease, degenerative and irreversible that is part of a group of diseases known as transmissible spongiform encephalopathies (TSEs) that affect various animal species, including humans.



## MICROCENTRIFUGE TUBES

*For more details please visit:*

*<http://www.biosigma.com/microcentrifuge-tubes.html>*

**A wide range of microcentrifuge tubes, screw caps and snap caps made of high transparency and medical grade raw materials, with a multitude of applications like molecular biology, research and clinical chemistry. Ideal for freezer storage, boiling application, centrifugation and for most standard microcentrifuge rotors.**

# MICROCENTRIFUGE TUBES

## MICROCENTRIFUGE TUBES WITH SCREW CAPS



Biosigma's microcentrifuge tubes are manufactured from medical-grade raw material to exceed the exacting standards demanded by researchers.

- ▶ 3 styles of caps to choose from and 6 sizes of conical bottom or self-standing tubes (0.5, 1.5 and 2ml)
- ▶ Withstand high speed centrifugation up to 16,400 rpm or 25.000xg and temperatures from -85°C to +121°C
- ▶ Autoclavable to 121°C. for 20 minutes
- ▶ Tubes made in medical polypropylene and cap in medical polyethylene
- ▶ Sterile SAL 10<sup>-6</sup>
- ▶ Certified DNase/RNase/Pyrogen free to satisfy the highest demands in several biotechnological applications

\*\* Raw materials tested in according to "the United States Pharmacopoeia" (USP) and with a "Drug Master File" (DMF) at the FDA.



CL604/S CL614/S CL616/S

Sterile microtube: 0.5 ml, o-ring cap

CAT. NO.	Height mm ±0.34	Bottom	O-Ring	Writing area	Collar	Int. pack	Sale unit
CL604/S	47.1	conical	X			bag / 500	case / 1000
CL606/S	48.5	conical	X		X	bag / 500	case / 1000
CL614/S	47.5	self standing	X			bag / 500	case / 1000
CL616/S	49.2	self standing	X		X	bag / 500	case / 1000



CL724/S CL734/S CL736/S

Sterile microtube: 1.5 ml, o-ring cap

CAT. NO.	Height mm ±0.34	Bottom	O-Ring	Writing area	Collar	Int. pack	Sale unit
CL724/S	47.1	conical	X	X		bag / 500	case / 1000
CL726/S	48.2	conical	X	X	X	bag / 500	case / 1000
CL734/S	47.6	self standing	X	X		bag / 500	case / 1000
CL736/S	49.0	self standing	X	X	X	bag / 500	case / 1000



CL744/S CL754/S CL754/AM CL756/S

Sterile microtube: 2.0 ml, o-ring cap

CAT. NO.	Color	Height mm ±0.34	Bottom	O-Ring	Writing area	Int. pack	Collar	Sale unit
CL744/S	neutral	47.2	conical	X	X	bag/500		case/1000
CL746/S	neutral	48.4	conical	X	X	bag/500	X	case/1000
CL754/S	neutral	48.6	self standing	X	X	bag/500		case/1000
CL754/AM*	amber	48.6	self standing	X	X	bag/1000		case/3000
CL754/SAM	amber	48.6	self standing	X	X	bag/500		case/1000
CL756/S	neutral	49.8	self standing	X	X	bag/500	X	case/1000

\* non sterile

**CLEARLine®**  
"Be cool, be safe, be CLEARLine"



CL600 CL610 CL720 CL730 CL740 CL750

Tube only (non sterile)

CAT. NO.	Vol. ml	Height mm ± 0.34	Bottom	Writing area	Int. pack	Sale unit
CL600	0.5	45.2	conical		bag / 1000	case / 3000
CL610	0.5	45.8	self standing		bag / 1000	case / 3000
CL720	1.5	45.2	conical	X	bag / 1000	case / 3000
CL730	1.5	45.8	self standing	X	bag / 1000	case / 3000
CL740	2.0	45.4	conical	X	bag / 1000	case / 3000
CL750	2.0	46.8	self standing	X	bag / 1000	case / 3000

Screw cap for microtube (non sterile)

Color	Flat cap + O-Ring	Cap suitable for cap disk + O-Ring	Cap suitable for cap disk with collar + O-Ring
High-mm ± 0.21	6.8	8.2	8.2
Diameter-mm ± 0.23	13.2	13.2	13.2
neutral	CL810	CL811	CL812
light blue	CL810/AZ	CL811/AZ	CL812/AZ
white	CL810/BI	CL811/BI	CL812/BI
yellow	CL810/G	CL811/G	CL812/G
pink	CL810/RA	CL811/RA	CL812/RA
red	CL810/RO	CL811/RO	CL812/RO
green	CL810/V	CL811/V	CL812/V
Internal pack.	bag / 1000	bag / 1000	bag / 1000
External pack.	case / 3000	case / 3000	case / 3000

All microtubes can be diversified by using color code inserts, as follow:

**CLEARLine®**  
Accessories



Cap disk

CAT. NO.	Color	Internal packaging	Sale unit
BSM910/AZ	light blue	bag / 1000	case / 1000
BSM910/RO	red	bag / 1000	case / 1000
BSM910/V	green	bag / 1000	case / 1000
BSM910/G	yellow	bag / 1000	case / 1000
BSM910/RA	pink	bag / 1000	case / 1000
BSM910/BI	white	bag / 1000	case / 1000

# MICROCENTRIFUGE TUBES

## CLEARLock™ MICROTUBES IN PP WITH SECURE LOCKING SYSTEM

# CLEARLock™

The best protection ever for your samples!



CLEARLock™ microtubes combine the security of a screw cap tube with the ease-of-use of a snap cap tube. They assure supreme protection to your samples by providing superior security during centrifugation, a precise sealing preventing evaporation, essential features during lab procedures.

CLEARLock™ microtubes have been specially studied and designed to withstand up to 30,000 xg during centrifugation without any rupture and to preserve the sample integrity.

The hinged lid prevents any unintentional opening during use especially when working with hazardous/precious samples or incubation. The precise sealing avoid also evaporation during long-term storage.

Human DNA, DNase, RNase, Pyrogen, ATP, PCR inhibitors free, each production batch is inspected and certified by an independent laboratory.



**CLEARLINE-PACKAGING**



**RECLOSABLE-ZIP BAG**



**HINGED-LID**



**HIGH SPEED CENTRIFUGATION**

- ▶ Hinged lid prevents any unintentional opening during use
- ▶ Precise lid sealing avoids evaporation during long-term storage
- ▶ Pierceable writing cap
- ▶ Optimal transparency
- ▶ Centrifuged at:  
0,5ml - 1,5ml - 2,0ml 17,500 rpm - 30,000 xg
- ▶ Temperature of use: -80°C + 100°C
- ▶ Autoclavable open at +121°C for 20 minutes
- ▶ Zip bags, re-closable

- ▶ Graduated with writing area
- ▶ Particularly suitable for application in PCR and other applications in molecular biology
- ▶ Manufactured in Clean Room Class ISO 8 (UNI EN ISO 14644-1). Class 100000 (US FED STD209E)
- ▶ Human DNA, DNase, RNase, Pyrogen, ATP, PCR inhibitors free certified\*
- ▶ CE-IVD marked \*

\* Certificate of analysis, and Declaration of conformity CE-IVD available for download on [www.biosigma.com](http://www.biosigma.com)

## CLEARLock™ 0.5, 1.5, 2.0 ml microtubes in PP with secure locking system



### Microtube in PP with locking system

CAT. NO.	Color	Volume (ml)	Internal packaging	Sale unit
<a href="#">CL05.001.0500</a>	neutral	0.5	bag/500	500
<a href="#">CL15.002.0500</a>	neutral	1.5	bag/500	1000
<a href="#">CL20.002.0500</a>	neutral	2.0	bag/500	1000

### Microtube in PP with locking system STERILE

CAT. NO.	Color	Volume (ml)	Internal packaging	Sale unit
<a href="#">CL05.050.0001S</a>	neutral	0.5	single bag	50
<a href="#">CL05.005.0100S</a>	neutral	0.5	bag/100	500
<a href="#">CL15.100.0001S</a>	neutral	1.5	single bag	100
<a href="#">CL15.004.0050S</a>	neutral	1.5	bag/50	200
<a href="#">CL20.100.0001S</a>	neutral	2.0	single bag	100
<a href="#">CL20.004.0050S</a>	neutral	2.0	bag/50	200

### Microtube in PP with locking system, in bulk

CAT. NO.	Color	Volume (ml)	Internal packaging	Sale unit
<a href="#">CL05.010.1000B</a>	neutral	0.5	bag/1000	10000
<a href="#">CL05.020.0500B</a>	neutral	0.5	bag/500	10000
<a href="#">CL15.010.1000B</a>	neutral	1.5	bag/1000	10000
<a href="#">CL15.020.0500B</a>	neutral	1.5	bag/500	10000
<a href="#">CL20.008.1000B</a>	neutral	2.0	bag/1000	8000
<a href="#">CL20.016.0500B</a>	neutral	2.0	bag/500	8000

### Microtube in PP with locking system, in bulk (not CLEARLine certified)

CAT. NO.	Color	Volume (ml)	Internal packaging	Sale unit
<a href="#">BSA05.010.1000</a>	neutral	0.5	bag/1000	10000
<a href="#">BSA05.020.0500</a>	neutral	0.5	bag/500	10000
<a href="#">BSA15.010.1000</a>	neutral	1.5	bag/1000	10000
<a href="#">BSA15.020.0500</a>	neutral	1.5	bag/500	10000
<a href="#">BSA20.008.1000</a>	neutral	2.0	bag/1000	8000
<a href="#">BSA20.016.0500</a>	neutral	2.0	bag/500	8000

# MICROCENTRIFUGE TUBES

## CLEARLock™ 5ml microtubes in PP with secure locking system

5 ML CLEAR LOCK™ microtubes are designed for samples too large for standard microcentrifuge tubes (1.5ml or 2.0ml) but in the meantime too small for 15 ml centrifuge tube. They ensure a contamination-free pipetting and they are the best choice when working with medium-sized sample volumes. In many applications it may replace the 15 ml test tubes, reducing the waste plastic, storage space needed and transport costs.

Secure locking system with audible closing click an additional guarantee during lab procedures.

CLEARLine® guaranteed purity. Tests and certificates are performed by an external independent laboratory, available on request.

Centrifuged at: 14,200 rpm - 21,000 x g  
Temperature of use: -80°C + 100°C  
Autoclavable open at +121°C for 20 minutes

Same diameter and conical bottom shape as a 15 mL conical tube allow use in existing centrifuge rotors, adapter and racks.



Easy-to-open cap reduces operator's hand fatigue preserving the sample integrity. Pierceable writing cap.

Graduated with writing area.

Made from highly transparent, chemical resistant Medical Grade polypropylene for easy visibility of pellets. Non Cytotoxic - Non Hemolytic

It may be used in all applications that require heating. Use the tube clips at temperature above 80°C to prevent cap opening and consequent sample loss.

### Microtube in PP with locking system



CAT. NO.	Color	Volume (ml)	Internal packaging	Sale unit
CL50.002.0100	neutral	5.0	bag/100	200

### Microtube in PP with locking system STERILE



CAT. NO.	Color	Volume (ml)	Internal packaging	Sale unit
CL50.050.0001S	neutral	5.0	single bag	50
CL50.010.0020S	neutral	5.0	bag/20	200

### Microtube in PP with locking system, in bulk



CAT. NO.	Color	Volume (ml)	Internal packaging	Sale unit
CL50.006.0500B	neutral	5.0	bag/500	3000
CL50.030.0100B	neutral	5.0	bag/100	3000

### Microtube in PP with locking system, in bulk (not CLEARLine certified)

CAT. NO.	Color	Volume (ml)	Internal packaging	Sale unit
BSA50.006.0500	neutral	5.0	bag/500	3000
BSA50.030.0100	neutral	5.0	bag/100	3000

### Technical drawing

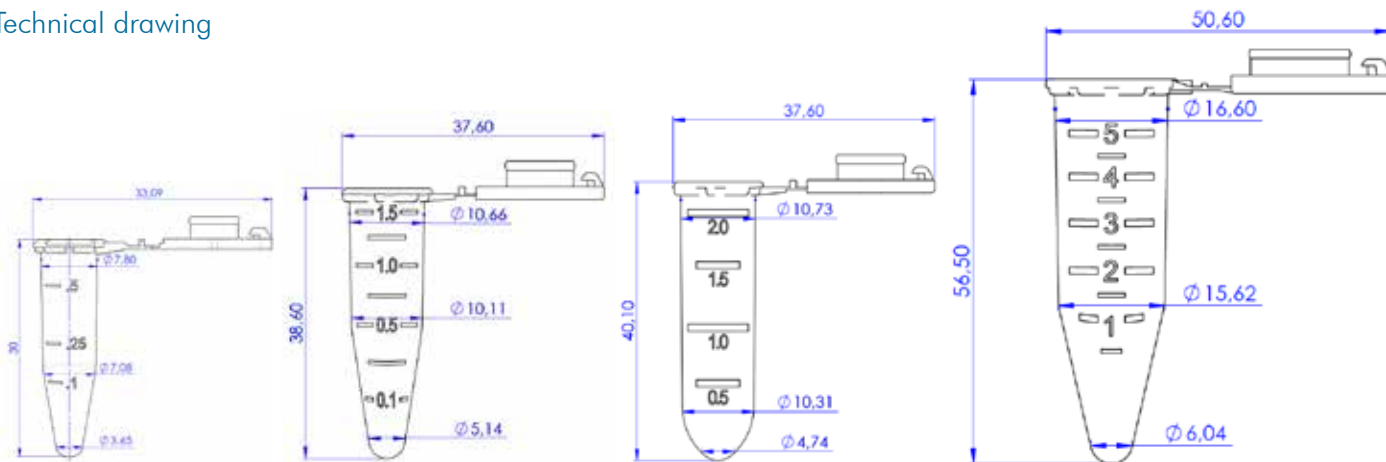

**CLEARLine®**  
"Be cool, be safe, be CLEARLine"



# MICROCENTRIFUGE TUBES

## 5 mL CENTRIFUGE TUBES SCREW CAP

5mL tubes take all of the conveniences of standard 15mL conical tubes and scale them down for space efficiency and decreased natural resource consumption. Usable from -86°C to 110°C, these tubes are a valuable resource for boiling and for sample preservation at very low temperatures.



CAT.NO	Description	Internal packaging	Sale unit
062627	5 mL centrifuge tube - non sterile, in bulk, screw caps aside, 16x64mm	100/bag	500/case
062628	5 mL centrifuge tube - sterile, screw caps attached, 10 racks. RNase, DNase & pyrogen free	50/rack	500/case

## ACCESSORIES FOR 5mL TUBES

### Cryobox in polycarbonate

Polycarbonate freezer box for 5ml tubes

- ▶ Suitable for -190 °C
- ▶ 13,33 x 13,33 x 6,99 cm
- ▶ 25x5ml tubes



### Tube clip for CLEARLock™ 5 mL microtube

Tube clip for CLEARLock™ 5ml microtube in polypropylene with secure locking system. Use the tube clip at temperature above 80 °C to prevent cap opening and consequent sample loss



CAT.NO	Description	Sale unit
062629	Polycarbonate freezer box for 5ml microtubes	5

CAT.NO	Description	Sale unit
933015	Tube clip for CLEARLock™ 5ml microtubes in PP with secure locking system	10



# MICROCENTRIFUGE TUBES

## 5 mL acrylic tube rack

- ▶ In crystal clear acrylic
- ▶ For 20 x 5 mL tubes
- ▶ Supported at two levels in the rack



CAT.NO	Description	Sale unit
141397	Acrylic rack for 20 x 5 mL tube	1

## 5ml / 15 mL tube rack

- ▶ 2 moving hinged upper shelves able to hold 5 mL or 15 mL tubes (up to 16 mm in diameter)
- ▶ Tear drop shaped openings for a better retention of tubes
- ▶ Printed grid of both sides of the upper shelves
- ▶ Dimensions : 30,9 x 10,7 x 7,7 cm
- ▶ Autoclavable at 121 °C for 15 min.



CAT.NO	Description	Color	Sale unit
320532	5ml / 15 mL tube rack, 40 wells	purple white	1
320533	5ml / 15 mL tube rack, 40 wells	green blue	1

## MyFuge™ 5 microcentrifuge

The MyFuge™ 5 microcentrifuge includes a four position rotor for compatibility with a variety of 5ml test tubes, including 5ml snap cap centrifuge tubes. In addition, this combination rotor has four additional slots for centrifuging standard microtubes (1.5/2.0ml). Simply close the lid and the centrifuge will quickly accelerate to reach the fixed speed of 5,500 rpm. Open the lid, and the rotor decelerates to a stop for removing samples.

The 5ml rotor position accepts 5ml centrifuge tubes (snap cap) directly. While 5ml blood and culture tubes (12x75mm) and cryovials are also accepted with the included adapters. The microtube positions are designed to accept 0.5 and 0.2ml tubes with the use of optional adapters.

- ▶ For quick spin downs of 5 mL and 1.5/2 mL tubes
- ▶ Includes adapters for 12 x 75 mm tubes
- ▶ Starts and stops with closing/opening of the lid
- ▶ Capacity : 4 x 5 mL tubes and 4 x 1.5/2 mL tubes

### Microcentrifuge

CAT.NO	Description	Sale unit
062586	MyFuge 5 microcentrifuge	1

### Specifications

Speed	5,500rpm
Max. RCF	2,000xg
Rotor	4 x 5ml tubes
Capacity	4 x 1.5/2.0 ml
Power	115V 50Hz or 230V, 60Hz
Dimensions [DxWxH]	14 x 20 x 14 cm
Weight	1 Kg



### Adapters

CAT.NO	Description	Sale unit
060974	Adapter for 0.5 mL tubes	6
060975	Adapter for 0.2 mL tubes	6
062589	Adapter for 0.5 mL and 2 mL cryovials and 1.5 - 2 mL HPLC vials	4

## ADAPTERS FOR OTHER MICROCENTRIFUGES

### Adapters for 5 mL tubes

For 1 CLEARLock™ 5 mL. Usable on centrifuges with rotors for conical 15 mL tubes.



CAT.NO	Description	Sale unit
933023	For 1 CLEARLock™ 5 mL. Usable on centrifuges with rotors for conical 15 mL tubes	8

### Adapters for 5 mL tubes

For 1 CLEARLock™ 5.0 mL. Usable on rotor FA-45-6-30.



CAT.NO	Description	Sale unit
933022	For 1 CLEARLock™ 5.0 mL. Usable on rotor FA-45-6-30	2

# MICROCENTRIFUGE TUBES

## MICROCENTRIFUGE TUBES WITH SNAP CAPS

Microtubes in PP 0.5, 1.5 and 2.0 ml **CLEARLine**



**CLEARLine**<sup>®</sup>  
"Be cool, be safe, be CLEARLine"



Microtube in polypropylene 1.5ml and 2.0ml, graduated, usable on EPPENDORF<sup>®</sup>. ClearLine

- ▶ Flat cap adapted for easy writing
- ▶ Centrifugable up to 25,000 x g
- ▶ In transparent polypropylene
- ▶ Evident graduation
- ▶ Autoclavable at 121°C (for 20 minute)
- ▶ DNase/RNase, Human DNA and Pyrogen free



CLEARLINE-PACKAGING



RECLOSABLE-ZIP BAG



WRITING-CAP

**AMBER VERSIONS,**  
available from  
January 2020



CL026

CL022

CL0269

Microtube in PP 0.5, 1.5 and 2.0 ml ClearLine

CAT.NO	Color	Volume (ml)	Internal packaging	Sale unit
CL026	neutral	0.5	bag/500	case/2000
CL026/AM	amber	0.5	bag/500	case/2000
CL022	neutral	1.5	bag/500	case/1000
CL022/AM	amber	1.5	bag/500	case/1000
CL0269	neutral	2.0	bag/500	case/1000
CL0269/AM	amber	2.0	bag/500	case/1000

## Microtubes in PP 0.5, 1.5 and 2.0 ml



Microtube in polypropylene 0.5, 1.5ml and 2.0ml, graduated, usable on EPPENDORF<sup>®</sup>. With or without cap

- ▶ Flat cap adapted for easy writing
- ▶ Centrifugable up to 25,000 x g
- ▶ In transparent polypropylene
- ▶ Evident graduation
- ▶ Autoclavable at 121°C (for 20 minute)



BSA026

BSA021

BSA022

BSA0269

BSA022/BLU

BSA022/G

BSA022/V

BSA022/RA

Microtube in PP 0.5, 1.5 and 2.0 ml, with or without cap

CAT.NO	Color	Vol. (ml)	Dimension (cm)	with cap	Internal packaging	Sale unit
BSA026	neutral	0.5	H 3.10 Ø 0.78	X	bag/1000	case/10000
BSA026/AM	amber	0.5	H 3.10 Ø 0.78	X	bag/1000	case/10000
BSA021	neutral	1.5	H 4.10 Ø 1.08		bag/1000	case/10000
BSA022	neutral	1.5	H 4.10 Ø 1.08	X	bag/500	case/8000
BSA022/AM	amber	1.5	H 4.10 Ø 1.08	X	bag/500	case/8000
BSA022/BLU	blue	1.5	H 4.10 Ø 1.08	X	bag/1000	case/10000
BSA022/G	yellow	1.5	H 4.10 Ø 1.08	X	bag/1000	case/10000
BSA022/RA	pink	1.5	H 4.10 Ø 1.08	X	bag/1000	case/10000
BSA022/V	green	1.5	H 4.10 Ø 1.08	X	bag/1000	case/10000
BSA0269	neutral	2.0	H 4.20 Ø 1.08	X	bag/1000	case/8000
BSA0269/AM	amber	2.0	H 4.20 Ø 1.08	X	bag/1000	case/8000

# MICROCENTRIFUGE TUBES

## RACKS\*

### 4-Way Racks

Polypropylene rack autoclavable to 121°C, arranged on 4 levels

- ▶ Lowest level: 12 holes for 0.2 ml microtubes
- ▶ Second level: 14 holes for 0.5 ml microtubes
- ▶ Third level: 12 holes for 1.5 and 2 ml microtubes
- ▶ Top level: The last line of holes (top level) is also a workstation for microtubes that can be opened and closed just using one hand. Thanks to the locking system the tubes can be securely locked and do not turn

**CLEARLine®**  
Accessories



CAT. NO.	Grid Color	Dimensions cm	Sale unit
BSM5827/AZ	light blue	L 18.5 P 12.0 H 5.50	case / 8
BSM5827/RO	red	L 18.5 P 12.0 H 5.50	case / 8
BSM5827/V	green	L 18.5 P 12.0 H 5.50	case / 8

### Racks for 100 tubes

Polypropylene rack for microtube from 1.5 to 2 ml.

- ▶ Supplied Flat (to be fitted)
- ▶ Stackable
- ▶ Marking surface on both sides
- ▶ Autoclavable
- ▶ Alphanumeric printing on the tray
- ▶ Colors available: white, blue, yellow, red
- ▶ Dimensions: 110 x 263 x 45 mm



CAT. NO.	Grid Color	Dimensions cm	Sale unit
391070	white	110 x 263 x 45	1
391071	blue	110 x 263 x 45	1
391072	yellow	110 x 263 x 45	1
391073	red	110 x 263 x 45	1

### Racks for 80 microtubes

Rigid rack for 80 microtubes 1.5 mL or 2 mL. L x w x h: 272 x 65 x 27 mm.

- ▶ Alphanumeric referencing
- ▶ Side handles
- ▶ Can be used from -90 °C to 121 °C (autoclavable)
- ▶ Economical
- ▶ Numerous colours
- ▶ Numerous accessories: storage box with lid, storage shelf

Rack standard colours		Rack fluorescent colours	
Color	CAT. NO.	Color	CAT. NO.
natural	840515	fluo yellow	840523
yellow	840519	fluo orange	840524
orange	840520	fluo pink	840525
red	840518	fluo blue	840526
violet	840521	fluo green	840527
blue	840516	-	-
green	840530	-	-
black	840522	-	-
assorted	840528	assorted	840529
Sale unit	5		5

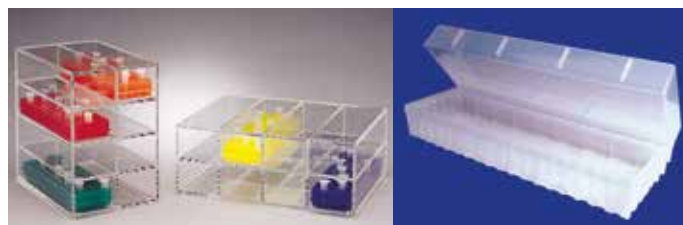

#### Storage box

Intended for individual storage of a loaded rack. Can be stacked, guarantees protection against contamination, formation of frost. Optimizes the storage space. Translucent lid with integrated hinge. Made from autoclavable polypropylene.

CAT. NO.	Description	Sale unit
045464	Storage box for rack of 80 microtubes natural colour	1

#### Acrylic shelves

The transparent acrylic shelves enable the racks to be stored and handled without stacking them. 12 tubes ø 25 mm

- ▶ Horizontal model:  
8 cases for 8 racks; L x w x h: 310 x 236 x 122 mm.
- ▶ Vertical model:  
8 cases for 8 racks; L x w x h: 157 x 236 x 234 mm.

CAT. NO.	Description	Sale unit
037579	Horizontal shelf for 8 racks of 80 microtubes	1
037580	Vertical shelf for 8 racks of 80 microtubes	1

\*For other racks see "Test tubes, stoppers, racks" on page 85



## CELL CULTURE

*For more details please visit:*

*<http://www.biosigma.com/cell-culture.html>*

A wide choice of cell culture ware products, spanning a variety of formats, sizes and surfaces. Our portfolio provides a range of essential cell culture consumables like as flasks, plates, centrifuge tubes to advance researchers' work with complete confidences

## CENTRIFUGE TUBES

### CLEARLine® Centrifuge Tubes



CLEARLine centrifuge tubes are applicable in molecular biology as disposable laboratory consumables which are manufactured from high transparency polypropylene. Two types of volume are available to meet general need: 15 ml and 50 ml. A ring molded on inner surface of cap make an excellent seal to prevent leak of liquid. Marking area is printed in white to make tube easy for identification. Clearly graduation in black on the surface is helpful for users to calibrate. Preferably, 3 ml graduation molded on conical bottom improves the accuracy of centrifuge tube.

All CLEARLine centrifuge tubes are packaged in bags or racks sterile, RNase-free, DNase-free and Non-pyrogenic.

- ▶ 15ml and 50ml volume
- ▶ High transparency polypropylene
- ▶ Molded ring in the cap inner surface grants an excellent seal to prevent leak of liquid
- ▶ White writing area for easy identification
- ▶ Black graduation
- ▶ Conical and self-standing bottom
- ▶ Can be centrifuged up to 14,800 x g for 50 ml and 10,280 x g for 15 ml centrifuge tubes
- ▶ Sterilised at gamma rays SAL 10<sup>6</sup>
- ▶ RNase-free, DNase-free and Non-pyrogenic
- ▶ Autoclavable at 121 °C during 20 min.

**CLEARLine®**  
"Be cool, be safe, be CLEARLine"



Packaging information:

- ▶ Lot number is printed on packaging for tracking
- ▶ Heat-sealed bag, reusable zip bag
- ▶ PS rack, heat shrinking pack



CL482  
15 ml



CL474  
50 ml



CL477  
50 ml



CL475  
50 ml

### CLEARLine Centrifuge tube-15-50 ml

CAT. NO.	Vol. (ml)	Dimensions (mm)	Centrifugation speed	Bottom style	Raw Material	Rack	Certifications	Inner Bag	Sale unit
CL474	50	116 x 28	12000 r/min; 14800 x g	Conical	polypropylene		RNase-free DNase-free Non-pyrogenic Sterile	25	500
CL475	50	116 x 28	12000 r/min; 14800 x g	Conical		X		25	500
CL477	50	118 x 28	12000 r/min; 14800 x g	Self standing				25	500
CL482	15	120 x 16	10000 r/min; 10280 x g	Conical				25	500
CL490	15	120 x 16	10000 r/min; 10280 x g	Conical		X		50	500

# CELL CULTURE

## Conical centrifuge tubes - large volume

- ▶ Sterile
- ▶ Integrated leak-proof cap
- ▶ Suitable from: - 80 to 120°C
- ▶ Conical bottom
- ▶ Volume: 225 ml
- ▶ Dimensions Ø x H: 60.2 x 137.5 mm



CAT. NO.	Description	Sale unit
978253	Centrifuge tube with conical bottom 225 ml	case / 48

## EASYstrainer sterile cell strainers

- ▶ Available in three sizes: 40, 70 and 100 µm
- ▶ Fit all standard 50 ml tubes
- ▶ Secure aseptic handling thanks to the small lateral handle and plastic envelope
- ▶ Venting slot between the tube and the filter: prevents liquid being trapped or leaks
- ▶ Single packed in blister packs



CAT. NO.	Color	Sterile	Description	Sale unit
542040	green	Yes	EASYstrainer sterile cell strainer - mesh 40 µm	50
542070	blue	Yes	EASYstrainer sterile cell strainer - mesh 70 µm	50
542000	yellow	Yes	EASYstrainer sterile cell strainer - mesh 100 µm	50

## CELL CULTURE FLASKS

- ▶ With vented screw cap
- ▶ Virgin polystyrene flask
- ▶ Easy to read volume scale
- ▶ Easy to stack
- ▶ Packaged in "peel-off" bags
- ▶ Treated for cell cultures
- ▶ Sterilized by gamma irradiation
- ▶ Certified as being RNase and DNase free
- ▶ Certified as having an endotoxin level of < 0.5 EU/ml
- ▶ Certificates available upon request
- ▶ Batch number and expiry date printed on every flask
- ▶ Model with filter cap: hydrophobic membrane prevents passage of bacteria, spores and particles larger than 0.2 µm



CAT. NO.	Volume (ml)	Surface (cm <sup>2</sup> )	Cap Style	Sterile	Units / Bag	Sale unit
131000C	50	25	vented	X	10	case / 200
131002C	250	75	vented	X	5	case / 100
131004C	600	175	vented	X	5	case / 40
131006C	50	25	filter	X	10	case / 200
131008C	250	75	filter	X	5	case / 100
131010C	600	175	filter	X	5	case / 40



Cell culture flasks treated for a good cell adhesion and particularly suited to the culture of adherent cells.

- ▶ Polystyrene flasks for single use
- ▶ Three culture surface areas: 25, 75 and 182 cm<sup>2</sup>
- ▶ Comes treated for the culture of adherent cells
- ▶ Flasks equipped with stacking rims
- ▶ Angled neck
- ▶ DNA, DNase, RNase, Pyrogen and Cytotoxine free
- ▶ Sterile



CAT. NO.	Surface (cm <sup>2</sup> )	Cap Style	Sterile	Units / Bag	Sale unit
690160	25	standard	X	10	case / 200
690170	25	squared	X	5	case / 100
690175	25	filter	X	5	case / 200
658170	75	standard	X	10	case / 200
658175	75	filter	X	5	case / 100
660160	182 Low	standard	X	-	case / 50
660175	182 Low	filter	X	-	case / 50
661160	182 High	standard	X	-	case / 40
661175	182 High	filter	X	-	case / 40



## MULTIWELL CELL CULTURE PLATES

- ▶ Special design to promote gas exchange
- ▶ Medical grade crystal polystyrene
- ▶ Treated for cell cultures
- ▶ Lid, large and deep spacing between the wells to prevent cross-contamination
- ▶ Serration areas on the sides ensure the user to always grips both the plate and lid
- ▶ Cut corner
- ▶ Identification alpha numeric of each well
- ▶ Single packed "peel-off"
- ▶ Sterilised by gamma irradiation
- ▶ Certified RNase, DNase free
- ▶ Certified an endotoxin level of < 0.5 EU/ml
- ▶ Certificates available on request

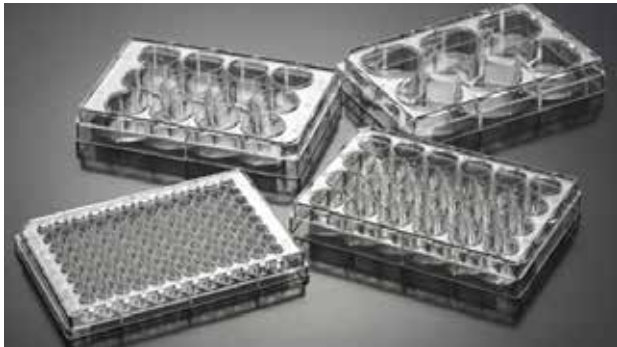

CAT. NO.	Surface (cm <sup>2</sup> )	Bottom	Max. well volume (ml)	Wells	Packaging
131028C	9.6	Flat	17	6	case / 100
131024C	3.85	Flat	6.8	12	case / 100
131020C	1.93	Flat	3.5	24	case / 100
131019C	0.84	Flat	1.55	48	case / 100
131012C	0.33	Flat	0.39	96	case / 100

## AERASEAL POROUS FILM

- ▶ Hydrophobic porous film with a thickness of 114 µm
- ▶ Medical grade adhesive
- ▶ Designed for deepwells with 96 wells and microplates for cultures or bacteriology
- ▶ Reduced risk of cross-contamination and evaporation
- ▶ Promotes uniform gas exchange in all wells
- ▶ Dimensions: 82.6 x 142.9 mm
- ▶ Non-cytotoxic
- ▶ Extremely gas permeable
- ▶ Can be easily pierced with a pipette tip to collect samples
- ▶ Can be used from -20°C to +80°C

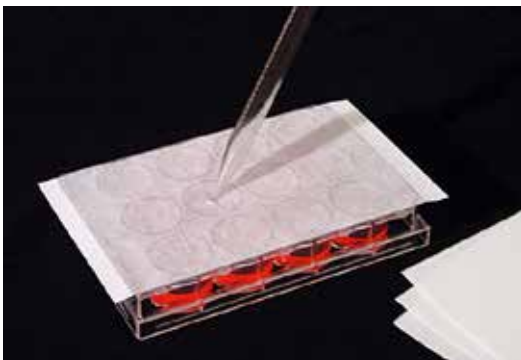

CAT. NO.	Description	Sale unit
760214	AeraSeal Adhesive film	case / 100
760215	Sterile AeraSeal Adhesive film	case / 50

## CLEARLine® PETRI DISHES

- ▶ Packaged in "peel-off" bags
- ▶ Sterilised by gamma irradiation
- ▶ Certified RNase and DNase free
- ▶ Certified an endotoxin level of < 0.5 EU/ml
- ▶ Certificates available on request



CAT. NO.	Surface (cm <sup>2</sup> )	Diameter	Sale unit
131046C	8.5	35	case / 960
131048C	21.2	60	case / 600
131050C	60.8	100	case / 300
131052C	143	150	case / 120

## CELL SCRAPERS

Sterile cell scraper for cell culture.

- ▶ Polyethylene
- ▶ Individually packaged
- ▶ Sterilised by gamma irradiation
- ▶ Pivoting polyethylene blade

CAT. NO.	Length	Sale unit
010153	180 mm	case / 100
010154B	250 mm	case / 100



## THINSEAL & SEALPLATE STERILE FILM

Sterile film for multiwell culture plates.

ThinSeal characteristics:

- ▶ Thickness of 25 µm
- ▶ Can be easily pierced with a pipette tip
- ▶ Dimensions: 79.4 x 141 mm

SealPlate characteristics:

- ▶ 50 µm polyester film
- ▶ Seals the plates hermetically
- ▶ Avoids rim effects
- ▶ The sterile version can be used for multiwell culture plates
- ▶ Film dimensions: 79.4 x 146 mm

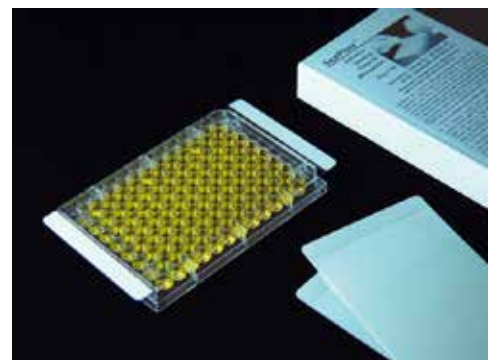

CAT. NO.	Description	Sale unit
760201	Sterile SealPlate Adhesive film - 50µm	case / 100
760205	Sterile ThinSeal Adhesive film - 25µm	case / 100



## PCR AND PLATES

*For more details please visit:*

*<http://www.biosigma.com/pcr-and-plates.html>*



## PCR MICROTUBES

### PCR microtubes 0.2 ml *M*ulti

- ▶ Microtube with domed or flat cap
- ▶ Thin wall for optimal and uniform heat transfer
- ▶ Pure polypropylene, very transparent
- ▶ Certified RNase and DNase free
- ▶ Suitable for all thermal cyclers

DNase  
RNase



#### PCR microtube 0.2 ml *M*ulti

CAT. NO.	Volume	Cap	Internal packaging	Sale unit
023190	0.2	domed	500	5000
023190A	0.2	domed	500	500
016950	0.2	flat	1000	10000
016950A	0.2	flat	1000	1000

### Individual PCR tubes 0.2 ml

- ▶ 0.2 ml PCR tube with flat or domed cap attached
- ▶ Excellent transparency and wall thinness
- ▶ RNase and DNase free

DNase  
RNase

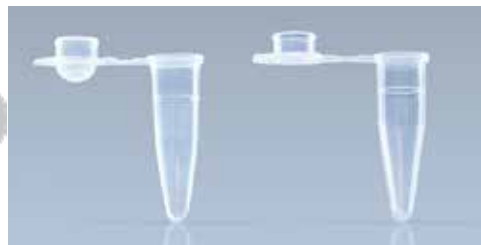

#### Individual PCR tube 0.2 ml

CAT. NO.	Volume	Cap	Sale unit
010159	0.2	domed	1000
010207	0.2	flat	1000

## PCR microtubes ABgene

- ▶ Thin walls for optimal and uniform heat transfer
- ▶ Pure polypropylene
- ▶ Certified human DNA, DNase and RNase free

DNase  
RNase

Human  
DNA



- ▶ With domed or flat cap
- ▶ Highly transparent
- ▶ Secure closing system

#### PCR microtube 0.2 and 0.5 ml with domed cap

CAT. NO.	Volume	Cap	Sale unit
016147	0.5	domed	1000

#### PCR microtube 0.2 and 0.5 ml with flat cap

CAT. NO.	Volume	Cap	Sale unit
016139	0.2	flat	1000
016155	0.5	flat	1000

### PCR microtubes - 0.65ml *M*ulti

- ▶ Thin wall
- ▶ Useful volume: 0.5 ml
- ▶ Total volume: 0.65ml
- ▶ DNA, DNase, RNase, Pyrogen, PCR inhibitor free

DNase  
RNase

Human  
DNA

PCR  
Inhibitors

Pyrogen



#### PCR Microtube: 0.65 ml *M*ulti

CAT.NO.	Volume	Sale unit
015160A	PCR Microtube: 0.65 ml <i>M</i> ulti	1000

### Safeseal microtubes - 0.65 ml

- ▶ Graduated with writable surface
- ▶ Guaranteed RNase & DNase free
- ▶ Centrifuged up to 26000g
- ▶ Autoclavable and freezable to resist from -80 °C to +121°C
- ▶ The AvantGuard microtubes are packed in bags and then in thin wall carton boxes
- ▶ Useful volume: 0.5 ml
- ▶ Total volume: 0.65 ml

DNase  
RNase



#### Microtube: 0.65 ml

CAT.NO.	Volume	Sale unit
017030A	Safeseal microtubes - 0.65 ml, natural color	1000
017030	Safeseal microtubes - 0.65 ml, natural color	20000

## PCR MICROTUBES IN STRIP

### PCR Microtubes 0.2 ml in strip *Multi*

- ▶ Extra thin wall in strips of 8
- ▶ Volume: 200  $\mu$ l
- ▶ Easy to cut into individual tubes
- ▶ Numerical labelling on each tube
- ▶ RNase, DNase free



116380

#### Microtube 0.2 ml strip *Multi*

CAT. NO.	Volume	Cap	Color	Sterile	Internal packaging	Sale unit
116380	0.2	domed	natural		250	2000
116280	0.2	domed	natural	X	120	960
138790	0.2	w/out	natural		250	2000

#### Cap in strip of 8 *Multi*

CAT. NO.	Volume	Cap	Color	Optical	Internal packaging	Sale unit
038780	0.2	domed	natural		250	2000
037990	0.2	flat	natural	X	250	2000

### ABgene® single cap microtubes in strips

In strips of 8 microtubes with individual caps for reducing the risk of cross contamination. Available in 3 versions including 2 for PCR: ultra transparent caps supplied with two types of tubes, white or natural colored.

- ▶ Detachable single tube
- ▶ Thin wall
- ▶ In virgin polypropylene
- ▶ Certified as free from DNase, RNase, human DNA and endotoxins



#### ABgene® single cap microtubes in strips

CAT.NO.	Volume	Sale unit
017261	Strips of 8 microtubes natural + individual caps ultra-clear	250
045405	Strips of 8 microtubes natural + individual domed caps	250

### Thermo-strip standard tubes

Microtube in strips of 8 or 12 for all makes of thermal cyclers. "Low Profile" to reduce dead volume and to remove condensation on the walls and thus limiting water evaporation. Very effective for small volumes less than 20  $\mu$ l.

- ▶ Detachable single tube



016303

#### Strip of 8

Description	Microtubes Standard		Microtubes Low profile	
Strip of 8 microtubes natural + domed cap	016000	016303	017868	016514
Strip of 8 microtubes mixed colours + cap	016000F	-	016166	-
Strips of 8 microtubes natural colour + flat cap	016561	-	017239	016389
Strips of 8 Low Profile microtubes - colour : assorted blue + flat caps	017867	-	016517	-
8 microtubes for quantitative PCR + caps	-	016562	017802	-
Strip of 8 microtubes without cap	016001	016164	-	016167
Internal packaging	250 x 8	12 x 8	250 x 8	12 x 8
Sale unit	250 x 8	120 x 8	250 x 8	120 x 8

#### Strip of 12

Description	Microtubes Standard	Microtubes Low profile
Strip of 12 microtubes + domed cap	016512	-
Strip of 12 microtubes + flat cap	016513	016518
Strip of 12 microtubes natural without cap	016511	-
Internal packaging	80 x 12	80 x 12
Sale unit	80 x 12	80 x 12

### PCR Microtubes 0.2 ml in strip with cap

- ▶ 8- tube strip and 8-cap strip domed or flat
- ▶ Excellent transparency and wall thinness
- ▶ RNase and DNase free
- ▶ Can be centrifuged at 6000 g
- ▶ Can be used from -20°C to 100°C
- ▶ Thin wall to facilitate heat transfer



010158

#### PCR tube 0.2 ml strip

CAT. NO.	Volume	Cap	Color	Internal packaging	Sale unit
010158	0.2	domed	natural	125	1000
010208	0.2	flat	natural	125	1000

# PCR AND PLATES

## PCR MULTI-MICROTUBE RACKS

It is possible to fix rack B for 96 microtubes of 0.2 ml onto rack A; it clips into the place intended for the individual 0.2 ml microtubes.

Rack A characteristics:

- ▶ Translucent lid included
- ▶ Choice of bright colours
- ▶ Stackable
- ▶ Alphanumeric index

Rack B characteristics:

- ▶ Microplate format
- ▶ With lid
- ▶ Can be used on its own or can be clipped onto rack A
- ▶ L x w x h: 126 x 86 x 33mm with lid, 126 x 86 x 11 mm without lid

Rack A capacity:

- ▶ 32 individual PCR microtubes - 0.2 ml
- ▶ 16 microtubes - 0.5 ml
- ▶ 24 microtubes - 1.5 ml or 2 ml

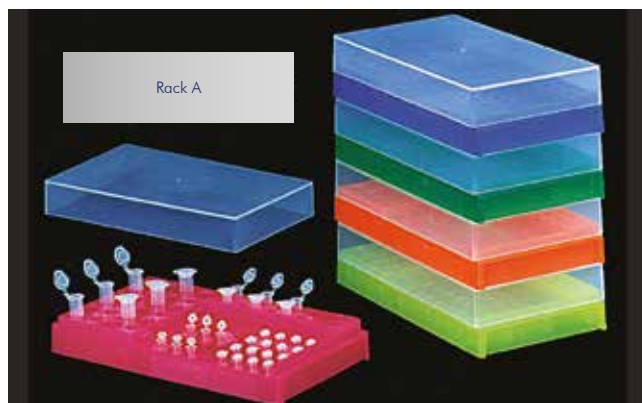

A: rack with lid for storage on one single side

CAT. NO.	Type	Color	Sale unit
045465	for storage of PCR microtubes - 0.2 ml - 0.5 - 1.5 - 2 ml	blue	1
045466		green	1
045467		orange	1
045468		pink	1
045469		yellow	1
045470		assorted	5

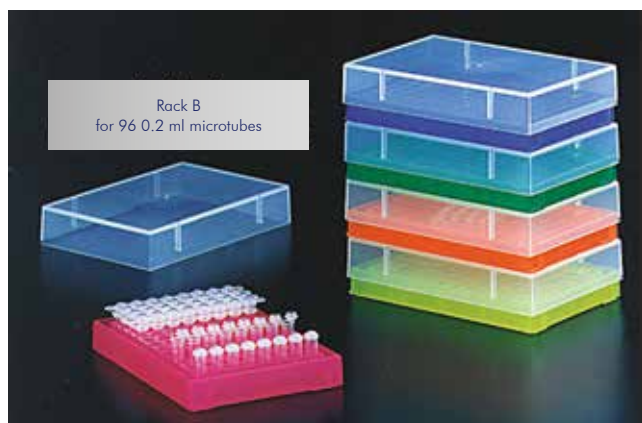

B: rack for 96 PCR microtubes - 0.2 ml

CAT. NO.	Type	Color	Sale unit
045471	for storage of 96 PCR microtubes - 0.2 ml	blue	1
045472		green	1
045473		orange	1
045474		pink	1
045475		yellow	1
045476		assorted	5

## STACKABLE RACK FOR PCR

Coloured polypropylene rack with transparent lid for 96 PCR tubes 0.2 ml or 1 PCR plate (with or without skirt).

Dimensions:

- 138 x 98 x 39 mm with lid;
- 138 x 98 x 30 mm without lid.

- ▶ Stackable with or without lid
- ▶ Self-locking lid
- ▶ 4 feet
- ▶ Accepts non-skirted, skirted or semi-skirted PCR plates, individual tubes or in strips of 8 or 12

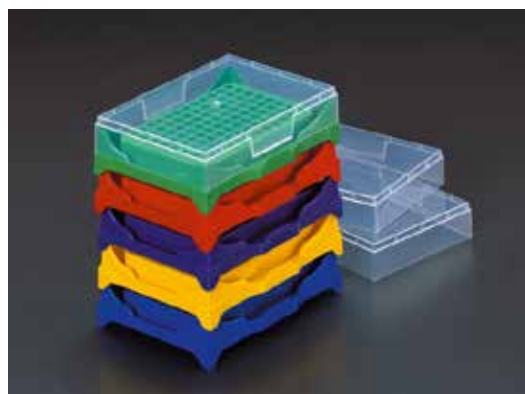

CAT. NO.	Description	Sale unit
045546	Set of 5 racks various colours (blue, yellow, red, green, purple) with lid	1

## STORAGE BOX WITH RACK FOR PCR

Stackable system, for freezing at -80 °C.

Cryobox characteristics:

- ▶ Autoclavable polypropylene made
- ▶ With hinged lid
- ▶ Dimensions: 143 x 143 x 59 mm
- ▶ Closing tab

Rack characteristics:

- ▶ Autoclavable polypropylene made
- ▶ Detachable
- ▶ For 96 PCR microtubes of 0.2 ml - in strips, plates or individually + 8 microtubes of 0.5 ml + 16 microtubes of 1.5/2 ml



CAT. NO.	Description	Sale unit
038787	PCR storage box with rack	1

## PLATES

PCR Plates with 96 wells for different thermal cycler types

- ▶ Thin polypropylene wall
- ▶ Available skirted, semi-skirted and non-skirted model
- ▶ DNA/DNase/RNase/PCR inhibitors and pyrogens free
- ▶ Black alphanumeric printing cut corner to facilitate plate orientation



PCR plate: 96 wells, semi-skirted



CAT. NO.	Color	Internal packaging	Sale unit
035800	natural	25	25
035900	natural	4 x 25	100



PCR plate: 96 wells, non-skirted



CAT. NO.	Color	Internal packaging	Sale unit
021970	natural	25	25
026190	natural	4 x 25	100



PCR plate: 96 wells, skirted



CAT. NO.	Color	Internal packaging	Sale unit
023080	natural	25	25
02844	natural	4 x 25	100

## ADHESIVE FILMS

### Adhesive film for PCR plate

ThermoQuick polycarbonate plates designed for PCR. The polycarbonate is characterised by an excellent resistance to high temperatures (to avoid any risk of plate deformation during the amplification cycle), and by its neutrality in relation to reagents and enzymes used.

- ▶ Excellent quick stick
- ▶ Good adhesion to a variety of polymers
- ▶ Performs over a wide temperature range (-15°C to +70°C)

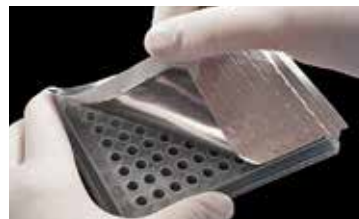

CAT. NO.	Material	Use Temperature	Dimensions (mm)	Sale unit
106524	plastic	-15 °C to +70 °C	117 x 78	100

### AlumaSeal film roll

- ▶ 38 µm thick piercable film with 38 µm adhesive
- ▶ Aluminium sheet for delayed evaporation of samples
- ▶ Use temperature: -80°C to + 120°C
- ▶ One roll for 830 plates
- ▶ Non-sterile
- ▶ Dim.: 80 mm x 100 m
- ▶ Bag supply
- ▶ DMSO Resistant
- ▶ Free from nucleases, nucleic acids and pyrogens
- ▶ Recommended for PCR, HTS and cold storage
- ▶ Easy piercing



CAT. NO.	Description	Sale unit
765248	Roll film AlumaSeal non-sterile, 80 mm x 100 m	1 roll

### AeraSeal film roll

- ▶ Porous and hydrophobic rayon film 114 µm
- ▶ With medical grade adhesive for cell cultures and 96-well plates used for bacterial culture
- ▶ Reduces evaporation and cross-contamination
- ▶ Improved and standardised gas exchange for all wells
- ▶ Temperature for use: -20°C to + 80°C
- ▶ One roll for 830 plates
- ▶ Easy piercing



CAT. NO.	Description	Sale unit
765247	AeraSeal film Roll- non-sterile, 81 mm x 100m	1 roll

## PCR PLATES FASTPLATE M $\mu$ LTi

Plate characteristics:

- ▶ 96-well plates with printed marking
- ▶ Specially designed for the thermal cyclers ABI 9800 and 7500 FAST
- ▶ Low profile, very clear
- ▶ Can also be used with most thermal cyclers

Reactive characteristics:

- ▶ "Inferno Master Mix" specially designed for the specific protocols of the ABI 9800
- ▶ The kit includes 2 Master Mix flasks (each 1250  $\mu$ l) that enable 250 reactions to be carried out
- ▶ The formula combines a Taq and a mix of buffers



### PCR plates Fastplate M $\mu$ lti

CAT. NO.	Description	Internal packaging	Sale unit
138800	PCR plate 96 wells FastPlate for ABI M $\mu$ lti	25 plates	1
138900	PCR plate 96 wells FastPlate for ABI M $\mu$ lti	4 x 25 plates	1
011670	Inferno Master Mix	2 x 1250 $\mu$ l	1

## PCR PLATES 96 AND 384 WELLS FOR LIGHT CYCLER<sup>®</sup>

- ▶ White colour
- ▶ Polypropylene
- ▶ Specially intended for the Light Cycler<sup>®</sup> Roche<sup>®</sup> thermal cycler
- ▶ RNase and DNase free
- ▶ Only to be used with sealing film reference 136590



### PCR plates 96 and 384 wells for Light Cycler<sup>®</sup>

CAT. NO.	Description	Sale unit
138870	PCR plate 96 wells for Light Cycler	100
138820	PCR plate 384 wells for Light Cycler	100
136590	Adhesive film for QPCR plate	100

## SEMI-SKIRTED 96-WELL PCR PLATES, M $\mu$ LTi REINFORCED DECK

Thin-wall 96-well plate, for all types of thermal cyclers.

- ▶ Alphanumeric well indexing printed in black
- ▶ Certified DNase, RNase, human DNA and pyrogen-free



### Plates

CAT. NO.	Description	Internal packaging	Sale unit
174370	Semi-skirted 96-well PCR plates, reinforced deck	4 Bags of 25	100

### Accessories

CAT. NO.	Description	Sale unit
490010	Septa mat for ABI 3100	10
712201	Septa mat silicone for ABI 3100	50
136590	Adhesive film for QPCR plate	100

## PCR PLATES 384 WELLS $\mu$ LTRA-PLATE M $\mu$ LTi

Rigid polypropylene plate with 384 wells for PCR.

- ▶ Total volume of each well: 40  $\mu$ l
- ▶ Working volume of each well: 25  $\mu$ l
- ▶ Can be autoclaved
- ▶ Certified as free from DNase and RNase

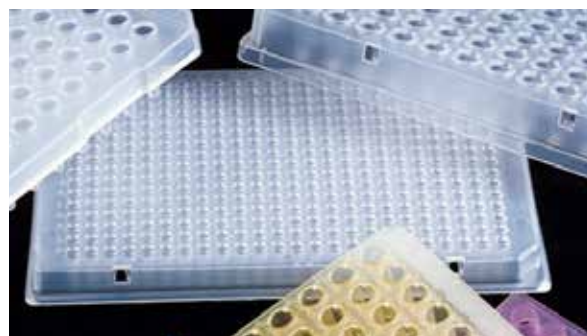

### PCR plates 384 wells $\mu$ ltra-Plate M $\mu$ lti

CAT. NO.	Description	Sale unit
039620	PCR plate 384 wells $\mu$ ltra-Plate natural colour M $\mu$ lti	50



# LIQUID HANDLING

For more details please visit:  
<http://www.biosigma.com/liquid-handling.html>

## ASPIRATION SYSTEM FOR SEROLOGICAL PIPETTES

- ▶ A full volume range: from 0.1 to 100 ml pipettes
- ▶ One-hand-use
- ▶ Lightweight, ergonomic design, fatigue-free pipetting
- ▶ Automatic adjustment of aspiration and dispenser speeds
- ▶ Lithium battery
- ▶ Low battery indication
- ▶ Aspires 50 ml in 5 seconds
- ▶ Large LCD display which provides visual confirmation of remaining battery charge and aspiration speed
- ▶ Fully autoclavable
- ▶ 0.45µm filter included

**CLEARLine®**  
Accessories



BS400201

BS400200

### Technical specifications BS400200

Aspiration speed	25 <5s (8shift)
Dispensing speed	Motor 8 speed + Gravity Dispense
Battery	Lithium
Battery life	8 Hours of discontinuous use
Charging time	Approx. 2-3 Hours
Pipettes types	Glass or plastic pipettes (0.1 - 100ml) or Pasteur pipettes
Filter	0.45µm hydrophobic
Weight	200g

### Automatic pipettor

CAT. NO.	Description	Sale unit
BS400200	BiPette automatic pipette filler	1
BS400201	0.45µm filter replacement for BS400200	1

- ▶ Comfortable and easy to use
- ▶ Precise pipetting control
- ▶ Robust and light
- ▶ Easy to maintain
- ▶ Suitable for volumetric and graduated pipettes, glass or plastic made, from 0.1 to 100 ml
- ▶ 4 colours

### Manual pipettor

CAT. NO.	Description	Colour	Sale unit
861000	Manual pipettor	blue	1
861001	Manual pipettor	red	1
861002	Manual pipettor	green	1
861003	Manual pipettor	yellow	1



861000

## CLEARLine® SEROLOGICAL PIPETTES



Serological pipette of 1 ml, 2 ml, 5 ml, 10 ml, 25 ml, 50 ml and 100 ml designed to be used with electromotion pipette controller and manual pipette pump to transfer liquid in various volume for laboratory use.

- ▶ CE - IVD marked
- ▶ Seven types of volume 1, 2, 5, 10, 25, 50 and 100 ml
- ▶ Bidirectional graduation and negative graduation improve the accuracy
- ▶ Color code on tips make pipettes easily recognizable
- ▶ Sterile at gamma rays 10<sup>6</sup>
- ▶ Packaged in bags
- ▶ Bulk packaging and individually packaging in plastic/paper wrapper
- ▶ RNase-free, DNase-free and Non-pyrogenic
- ▶ Graduation calibrated, certificate available on request

Packaging information

Lot number printed on packaging for tracking

- ▶ Plastic/paper wrapper easy to open



**CLEARLine®**  
"Be cool, be safe, be CLEARLine"

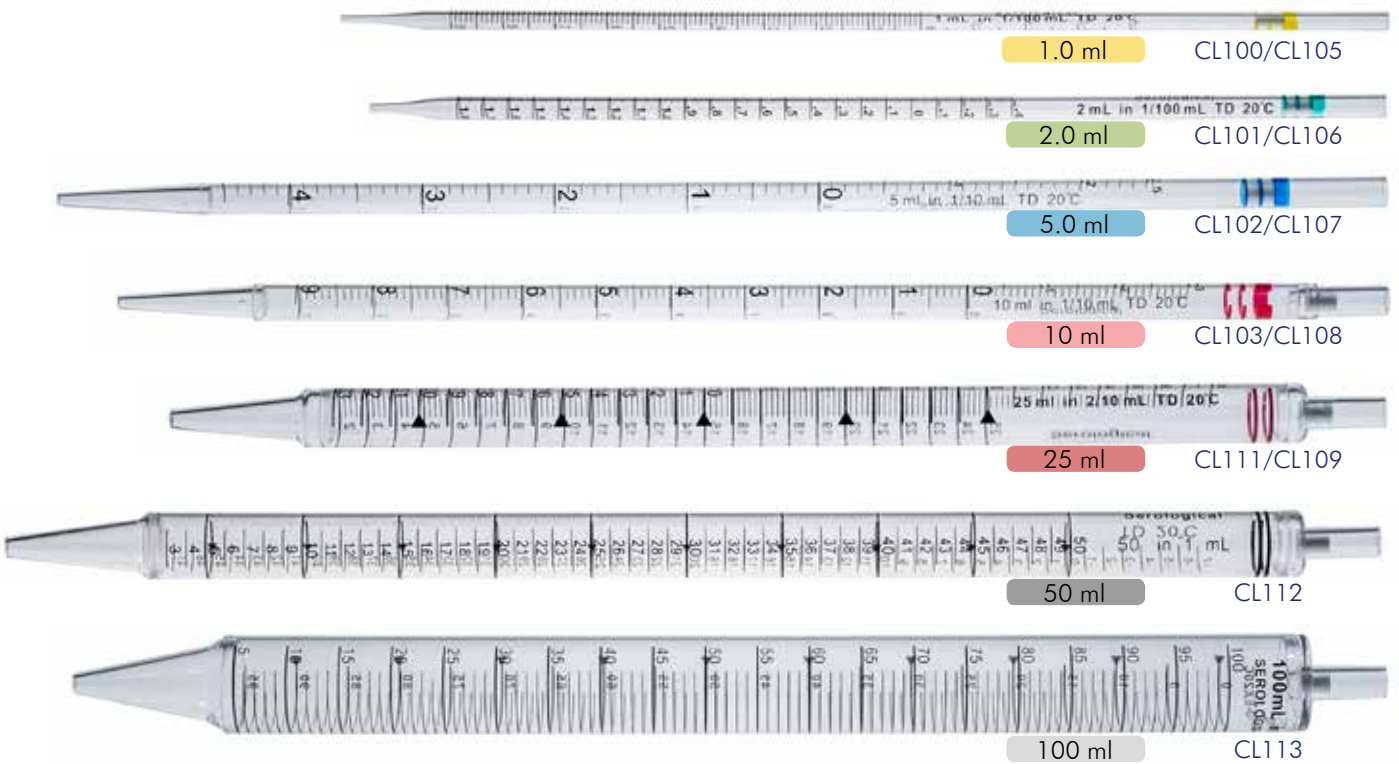

### Sterile individually wrapped

CAT. NO.	Volume (ml)	Graduation	Internal Packaging	Sale unit
CL100	1	1/100	100	1000
CL101	2	1/100	100	800
CL102	5	1/10	50	300
CL103	10	1/10	50	200
CL111	25	2/10	50	200
CL112	50	1 ml	25	100
CL113	100	1 ml	50	50



### Sterile in bags

CAT. NO.	Volume (ml)	Graduation	Internal packaging	Sale unit
CL105	1	1/100	25	1000
CL106	2	1/100	25	800
CL107	5	1/10	25	500
CL108	10	1/10	25	350
CL109	25	2/10	25	350



Color code on tips make pipettes easily recognizable

## MANUAL MICROPIPETTES WITH EJECTORS FULLY AUTOCLAVABLE

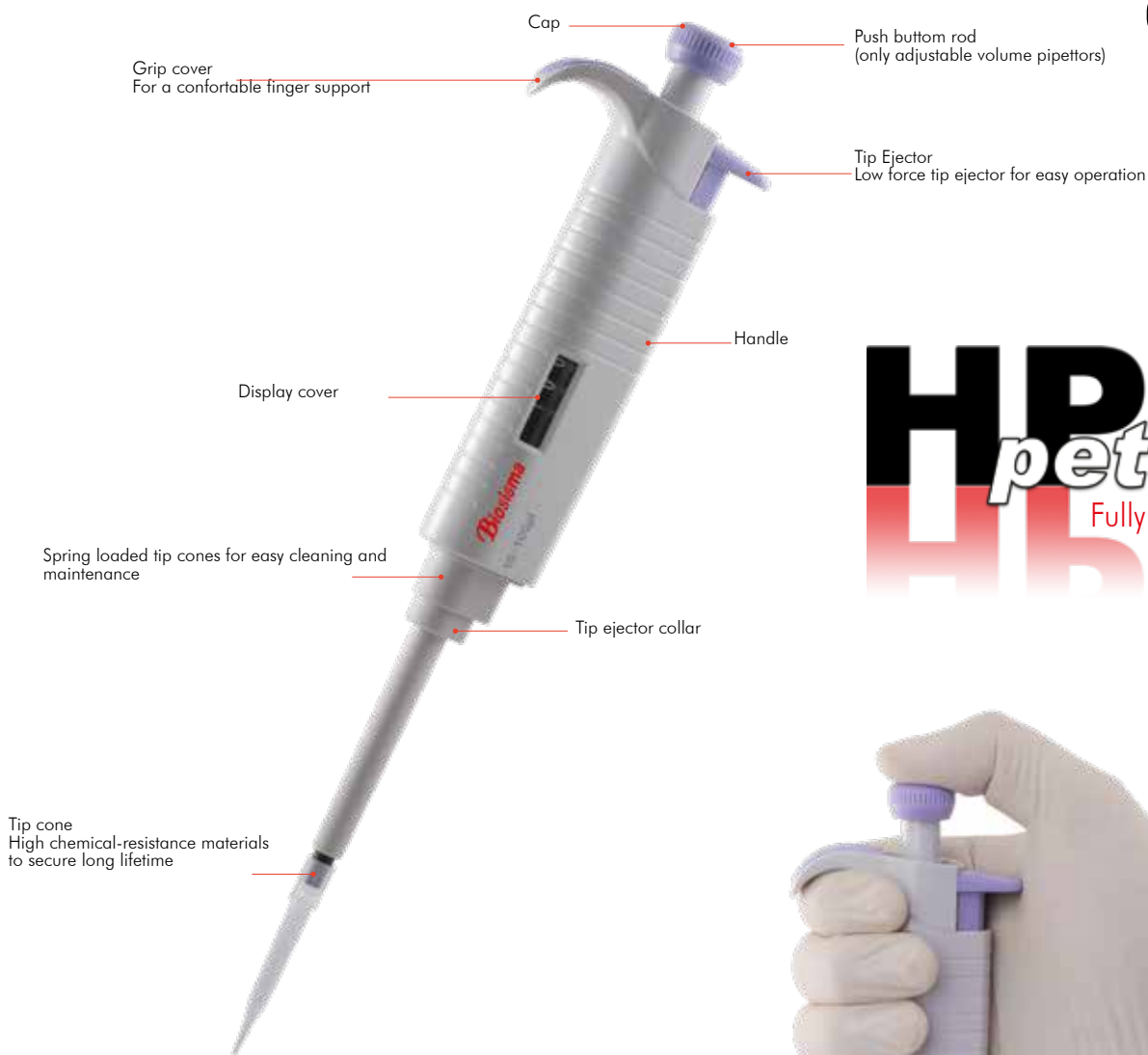

### FEATURES

- ▶ Fully autoclavable
- ▶ Slim design and light in weight, less risk of strain injuries.
- ▶ Compatible with most universal tip brands
- ▶ Excellent grip
- ▶ User friendly
- ▶ Large display window allows for easier volume identification
- ▶ Ejector button on the back for easy identification
- ▶ Pipettes cover volume range from 0.1 µL to 5 mL
- ▶ Easy calibration and maintenance
- ▶ Each pipette is supplied with an individual calibration certificate according to ISO8655 performed in factory
- ▶ CE marked as in vitro diagnostic device according to Directive 98/79/EC

for compatibility with tips see pages 51 and 53

### Fix volume

CAT. NO.	Volume (µl)	Sale unit
ABS119HPA	5	1
ABS120HPA	10	1
ABS121HPA	20	1
ABS1210HPA	25	1
ABS122HPA	50	1
ABS123HPA	100	1
ABS124HPA	200	1
ABS1240HPA	250	1
ABS1241HPA	500	1
ABS125HPA	1000	1

### Adjustable volume

CAT. NO.	Volume (µl)	Sale unit
ABS1261HPA	0.1 - 2.5	1
ABS126HPA	0.5 - 10	1
ABS128HPA	2 - 20	1
ABS129HPA	5 - 50	1
ABS1290HPA	10 - 100	1
ABS131HPA	20 - 200	1
ABS1310HPA	50 - 200	1
ABS1311HPA	100 - 1000	1
ABS132HPA	200 - 1000	1
ABS127HPA	1000 - 5000	1





## FEATURES

- ▶ Fully autoclavable
- ▶ 8 channel pipette are appropriate for 96-well plates
- ▶ Dispensing head rotates for effortless pipetting convenience
- ▶ Individual piston and tip cone assemblies allowing easy repair and maintenance
- ▶ Compound material-made tip cone secures high sealing performance
- ▶ Compatible with most universal tip brands

### Multichannel 8 channel

CAT. NO.	Volume (µl)	Compatible Tip	Sale unit
ABS133HPA	5 - 50	BSR066	1
ABS135HPA	50 - 300	BSR074	1
ABS136HPA	0.5 -10	BSR064	1

## Fully autoclavable

The HP-Pette Plus are fully autoclavable enable easy cleaning to reduce the risk of contamination. Steam autoclaving can be performed at 121 °C, 1 bar for 20 minutes. After autoclaving the pipette must be cooled down and left to dry for 12 hours before use. It is recommended to check the performance of the pipette after each autoclaving. Greasing and sealing of the pipette piston after every 10th autoclaving will secure an enhanced function.



- ▶ Suitable for all pipette models
- ▶ With 5 stations
- ▶ The carousel stand rotates smoothly and comfortably
- ▶ It holds up to 6 pipettes

### Rack

CAT. NO.	Description	Sale unit
861006	Pipettor stands in ABS for major pipettor brands.	1
861055	Carousel pipette stand, suitable for 6 pipettes.	1



## STERILE PS REAGENT RESERVOIRS IN 25, 50, 100 ml

- ▶ In medical polystyrene
- ▶ Available Sterile and not
- ▶ Made in clean room
- ▶ Human DNA, RNase, DNase, non pyrogenic free
- ▶ Sterile SAL 10<sup>-6</sup>
- ▶ Angles with deposit system
- ▶ Graduated (volume accuracy +/- 5 %)
- ▶ V bottom to maximize the samples' rescue
- ▶ Non autoclavable



### Standard reservoir in white polystyrene

Vol. (ml)	Non sterile bag / 100	Sale unit	Sterile bag / 1	Sale unit	Sterile bag / 5	Sale unit
25	097805	100	097801	100	097800	200
50	097819	100	097802	100	097803	200
100	097804	100	087806	100	087807	200

### 3 channel reservoirs in white polystyrene

Volume (ml)	Sterile bag / 1	Sale unit	Sterile bag / 5	Sale unit
25	087804	100	087805	200

# LIQUID HANDLING

## STANDARD TIPS

Several tip models utilizable with the most important pipette brands of the market.  
Available in bulk and rack both. Made of Polypropylene  
Autoclavable racks



Example of tips bag



Example of tips in rack  
0 - 200 µl



Example of tips in rack  
200 - 1000 µl



Example of tips in  
blister of 5 pcs

### Tip: EPPENDORF® type

Photo	CAT. NO.	Volume (µl)	Color	Sterile	Internal packaging	Sale unit	Compatibility
	BSR062	0-10	neutral		Bag 1000 pcs	25000	Eppendorf® Cristal
	BSR063			Rack 96 pcs	9600		
	BSR0625	0.5-10		X	Blister 5 pcs	1000	Eppendorf® - Gilson® - Socorex® - HHL® - Nichiryo®
	BSR001	0-200	yellow		Bag 1000 pcs	25000	Eppendorf® - Brand® - Socorex®
	BSR041			Rack 96 pcs	9600		
	BSR011	5-100		X	Blister 5 pcs	2000	Eppendorf® - Gilson® - Socorex® - Nichiryo® - Pipetman® - Brand® - Clinipette® - Biohit® - Labssystem® - Excalibur® - HTL® - FinnpiPETTE®
	BSR002	200-1000	blue		Bag 500 pcs	10000	Eppendorf® - Socorex® - HTL® - Nichiryo®
	BSR042		light blue	Rack 96 pcs	9600		
	BSR012	100-1000	blue	X	Blister 5 pcs	1000	Eppendorf® - Gilson® - Socorex® - Nichiryo® - Pipetman® - Brand® - Clinipette® - Biohit® - Labssystem® - Excalibur® - HTL® - FinnpiPETTE®
	BSR080	1000-5000	neutral		case 250 pcs	2000	Eppendorf® - Socorex® - Biohit® - Oxford® - Acura®

### Tip: GILSON® type

Photo	CAT. NO.	Volume (µl)	Color	Sterile	Internal packaging	Sale unit	Compatibility
	BSR064	0.1-10	neutral		Bag 1000 pcs	10000	Gilson® - Eppendorf® - Socorex® - Nichiryo® - Jencons® - Biohit® Old Model - Elakay® - HTL® - FinnpiPETTE®
	BSR076			Rack 96 pcs	960		
	BSR066	0-200	yellow		Bag 1000 pcs	25000	Gilson®
	BSR0665	5-200		X	Blister 5 pcs	1000	
	BSR067	100-1000	blue		Bag 1000 pcs	10000	Gilson® - Eppendorf® - Socorex® - HTL® - Nichiryo®
	BSR075			Rack 96 pcs	960		

### Tip: MLA® type

Photo	CAT. NO.	Volume (µl)	Color	Sterile	Internal packaging	Sale unit	Compatibility
	BSR008	10-200	neutral		Bag 1000 pcs	12000	Mla® - Oxford®
	BSR018			X	Blister 5 pcs	2000	
	BSR048/N			Rack 192 pcs	960		
	BSR009	100-1000	neutral		Bag 1000 pcs	10000	Mla® - FinnpiPETTE® Colour model
	BSR019			X	Blister 5 pcs	500	
	BSR049/N	250-1000			Rack 192 pcs	960	Mla®

### Tip: Oxford® type

Photo	CAT. NO.	Volume (µl)	Color	Sterile	Internal packaging	Sale unit	Compatibility
	BSR004	5-200	neutral		Bag 1000 pcs	10000	Oxford® slim line - Diamed®
	BSR014			X	Blister 5 pcs	500	
	BSR003	10-200	neutral		Bag 1000 pcs	22000	Oxford® - FinnpiPETTE®
	BSR013			X	Blister 5 pcs	1500	
	BSR007	101-1000	blue		Bag 1000 pcs	10000	Oxford®
	BSR017			X	Blister 5 pcs	500	

# LIQUID HANDLING

## Standard Tips compatibility with HPpette

Match the right tip to each HPpette

Micropipettes		Micropipettes Single channel														Multichannel 8 channel										
		Adjustable volume							Fix volume																	
		ABS1261HPA 0.1-2.5µl	ABS126HPA 0.5-10µl	ABS128HPA 2-20µl	ABS129HPA 5-50µl	ABS1290HPA 10-100µl	ABS131HPA 20-200µl	ABS1310HPA 50-200µl	ABS1311HPA 100-1000µl	ABS132HPA 200-1000µl	ABS127HPA 1000-5000µl	ABS119HPA 5µl	ABS120HPA 10µl	ABS121HPA 20µl	ABS1210HPA 25µl	ABS122HPA 50µl	ABS123HPA 100µl	ABS124HPA 200µl	ABS1240HPA 250µl	ABS1241HPA 500µl	ABS125HPA 1000µl	ABS136HPA 0.5-10µl	ABS133HPA 5-50µl	ABS135HPA 50-300µl		
<b>Tips</b>	X = compatible																									
BSR062	0-10 µl neutral	X	X								X	X												X		
BSR063	0-10 µl neutral	X	X								X	X												X		
BSR0625	0.5-20 µL neutral	X	X								X	X											X			
BSR001	0-200 µl yellow			X	X	X	X	X					X	X	X	X	X									
BSR041	0-200 µl yellow			X	X	X	X	X					X	X	X	X	X									
BSR011	5-100 µl yellow			X	X	X	X	X					X	X	X	X	X									
BSR064	0.1-10 µl neutral	X	X																				X			
BSR076	0.1-10 µl neutral in rack 96 pcs	X	X																				X			
BSR066	0-200 µL yellow			X	X	X	X	X					X	X	X	X	X							X		
BSR0665	5-200 µL yellow			X	X	X	X	X					X	X	X	X	X							X		
BSR002	200-1000 µL blue									X	X							X	X	X						
BSR042	200-1000 µL light blue									X	X							X	X	X						
BSR012	100-1000 µL blue																									
BSR074	2-300 µl neutral in rack 96 pcs																								X	
BSR067	100-1000 µl blue									X	X							X	X	X						
BSR075	100-1000 µl blue									X	X							X	X	X						
BSR080	1000-5000 µl neutral										X															
BSR008	10-200 µL neutral			X	X	X	X	X					X	X	X	X	X									
BSR018	10-200 µL neutral			X	X	X	X	X					X	X	X	X	X									
BSR048/N	10-200 µL neutral			X	X	X	X	X					X	X	X	X	X									
BSR009	100-1000 µL neutral																									
BSR019	100-1000 µL neutral																									
BSR049/N	250-1000 µL neutral																									
BSR004	5-200 µL neutral																									
BSR014	5-200 µL neutral																									
BSR003	10-200 µL neutral																									
BSR013	10-200 µL neutral																									
BSR007	101-1000 µL neutral																									
BSR017	101-1000 µL neutral																									

## CLEARLine® STERILE FILTER TIPS, RACKED, IN LIFT-OFF LID BOXES

Your solution for liquid samples.

- ▶ Filtered tip, in natural polypropylene, racked, available in lift-off lid boxes
- ▶ Certified DNase, RNase-free, human DNA, PCR inhibitors and Pyrogen free
- ▶ Sterile
- ▶ The ISO 8655 norm, as established by an independent laboratory, guarantees that the ClearLine® tips do not alter the pipette's technical specifications as set by their manufacturer - Visit [www.dutscher.com/clearline](http://www.dutscher.com/clearline) to view the tips' compatibility test results with your pipettes.
- ▶ Autoclavable at 121°C
- ▶ Supplied in a rack with removable lid, for under hood use



Certificate ISO-8655



Available:

- ▶ In standard virgin polypropylene
- ▶ In low Binding: the tip, hydrophobic PP made, reduces the surface tension with two benefits: a maximal sample refund and a minimal retention of DNA and proteins (weakest retention respect to the standard one)

### Certification ISO-8655

**CLEARLine®**  
"Be cool, be safe, be CLEARLine"

ClearLine®



Model	Volume (µl)	Features	Compatibility	Standard		Low Binding	
				CAT. NO.	Sale unit	CAT. NO.	Sale unit
Microguard 10G	0.1-10 µl	Small volume Tips (28.8 mm)	Gilson P2-P10, Finnpiquette 2-10 µl Biohit 2.5-10 µl	028200CL	10x96	035200CL	10x96
MicroReach Guard	0.1-10 µl	Universal Long (45 mm)	Gilson P2-P10 Eppendorf 10 µl Finnpiquette 2-10 µl Biohit 2.5-10 µl	038000CL	10x96	038000TCL	10x96
Microguard 10XL	0.1-10 µl	Universal Long (45 mm)	Gilson P2-P10 Eppendorf 2.5 µl – 10 µl Finnpiquette 2-10 µl Biohit 2.5-10 µl	130340CL	10x96	-	-
Multiguard 10E	0.5-10 µl	Crystal Long tips (45.5 mm)	Eppendorf 10 µl Socorex 10 µl	015020CL	10x96	035210CL	10x96
Multiguard 20 µl	1-20 µl	Universal (50.7 mm)	Gilson P20 Eppendorf 20 µl Finnpiquette 10-20 µl Socorex 20 µl	014210CL	10x96	035220CL	10x96
Multiguard 100 µl	1-100 µl	Universal (50.7 mm)	Gilson P100 Biohit 50-100 µl Eppendorf 100 µl Finnpiquette 50-100 µl Socorex 100 µl	036060CL	10x96	036060TCL	10x96
Multiguard 200 µl	1-200 µl	Universal (50.7 mm)	Gilson P200 Eppendorf 200 µl Finnpiquette 200 µl Socorex 200 µl	014220CL	10x96	035230CL	10x96
MultiGuard3 and 200 µl	1-2 µl 1-100 µl 1-200 µl	Long Tips (78.0 mm)	Gilson P20 – P100 – P200 Biohit 50-100 µl Eppendorf 20-100-200 µl Finnpiquette 10-20-50-100-200 µl	017370CL	10x96	035240CL	10x96
Multiguard 300 XT	1-300 µl	Long Tips (78.0 mm)	Gilson P200 Biohit 250 µl Eppendorf 200 µl Finnpiquette 200 µl	130510CL	10x96	130510TCL	10x96
Multiguard 1000 µl	100-1000 µl	Universal (71.8 mm)	Gilson P1000 Eppendorf 1000 µl Finnpiquette 1000 µl Biohit 1000 µl Socorex 1000 µl	014200CL	10x100	035260CL	10x100
Multiguard 1250 µl	50-1250 µl	Long Tips (102 mm)	for pipettes 1000 µl	134000CL	8x96	-	-

### Non-filter tips, racked, lift-off lid

### Standard tips

### Low-binding tips

Volume (µL)	Description	Compatibility	Qty	Non-sterile	Sterile	Non-sterile	Sterile
0.1 - 10	45 mm long, fine tip	Universal	10 x 96	030560ACL	030570ACL	-	-
0.1 - 10	45 mm long tip	Universal	10 x 96	037640CL	037660CL	037640TCL	037660TCL
1 - 200	Universal tip, natural colour - length 50.7 mm	Universal	10 x 96	032230CL	032250CL	-	035100ACL
1 - 200	Universal graduated tip, yellow - length 50.7 mm	Universal	10 x 96	032240CL	032260CL	-	-
100 - 1000	Universal tip, blue - length 72.8 mm	Universal	10 x 100	027110CL	027120CL	-	-
50 - 1250	102 mm long tip	Universal	8 x 96	134750CL*	134760CL*	-	-

\* Supplied in a rack with hinged lid



## CLEARLine® FILTER AND STANDARD TIPS, HINGED LID RACK

### Tips

CLEARLine® filter tips, racked, hinged lid

- ▶ Sterile filter tips
- ▶ Low-binding filter tips : maximal sample recovery for increased precision
- ▶ Universal compatibility

ClearLine® Tips with hinged-lid rack



Certification CE / IVD / ISO-8655

**CLEARLine®**  
"Be cool, be safe, be CLEARLine"

CE

IVD

ClearLine®

DNase  
RNase

Human  
DNA

PCR  
Inhibitors

Endo-  
toxins

Pyrogen

Eco-friendly System!

Combine ClearLine® filter and non-filter tips to reduce waste:  
Hinged lid boxes are also compatible with ClearLine®-reload rack



Photo	CAT. NO.	Sterile filter tips Low Binding	Sterile tips without filter	Volume (µl)	Tray Color	Description	Int. pack.	Sale unit
	713130		713136	10	red	10 µl graduated tip Length: 31.24 mm	10 x 96	960
	713114		713135	10	red	10 µl graduated long tip Length: 45.87 mm	10 x 96	960
	713115		-	20	yellow	20 µl graduated tip Length: 50.75 mm	10 x 96	960
	713116		-	100	yellow	100 µl graduated tip Length: 59.54 mm	10 x 96	960
	713117		713137	200	yellow	200 µl graduated tip Length: 59.54 mm	10 x 96	960
	713131		713138	300	green	300 µl graduated tip Length: 59.54 mm	10 x 96	960
	713118		713139	1000	blue	1000 µl graduated tip Length: 81.78 mm	8 x 96	768
	713119		713140	1250	blue	1250 µl graduated tip Length: 98.40 mm	8 x 96	768

NB: Picture are not in scale

## CLEARLine® reload system



Reload tips system ClearLine® with hinger-lid rack  
Empty box are sold separately

### CLEARLine® reload system

- ▶ Quick, simple reload system
- ▶ Standard non-filter tips, non-sterile, compatible with most pipette brands
- ▶ Eco-friendly: cardboard packaging (reduces plastic waste)
- ▶ Space saving: requires 57% less space than other reload systems
- ▶ The non-filter tip racks from the reload system are compatible with the ClearLine® hinged lid boxes for filter tips (this system is a great way of easily reducing plastic waste)

**Certification CE / IVD / ISO-8655**

**CLEARLine®**  
"Be cool, be safe, be CLEARLine"



Photo	CAT. NO.	Recharge	Volume (µl)	Tray Color	Description	Int. pack.	Sale unit
		standard					
	713128		10	red	10 µl graduated tip Length: 31.24 mm	10 x 96	960
	713110		10	red	10 µl graduated long tip Length: 45.84 mm	10 x 96	960
	713111		200	yellow	200 µl graduated tip Length: 50.75 mm	10 x 96	960
	713129		300	green	300 µl graduated tip Length: 59.54 mm	10 x 96	960
	713112		1000	blue	1000 µl graduated tip Length: 81.78 mm	8 x 96	768
	713113		1250	blue	1250 µl graduated tip Length: 98.40 mm	8 x 96	768

NB: Picture are not in scale

## Empty boxes for CLEARLine® reload system

CAT. NO.	Description	Internal packaging	Sale unit
713120	Empty boxes for Clearline® 10-300 µL racked tips	10	10
713121	Empty boxes for Clearline® 1000-1250 µL racked tips	8	8



### Eco-friendly System!

Combine ClearLine® filter and non-filter tips to reduce waste:  
**Hinged lid boxes are also**

**compatible with ClearLine® reload rack**



## ONE TOUCH® BI-COMPONENT TIPS

The One Touch tip from Multi represents a major innovation in the field of liquid sample handling.

Revolutionary packaging, the cardboard rack E.DEK: limit your plastic waste! Thanks to the implementation of the two components, the pressure required for the installation of the One Touch tips on the pipette is a lot lower than when using traditional tips. It is therefore possible to pack One Touch tips in cardboard racks without them being crushed during handling. Insert the pipette into the tip (or the multichannel pipette into the row of 8 or 12 tips). A small amount of pressure is enough to install the tip with perfect impermeability. This unique, ecological presentation limits plastic waste and helps to protect the environment.

- ▶ Innovative production process: bi-component tip
- ▶ Tip's body in virgin polypropylene
- ▶ Upper part in flexible elastomer
- ▶ Optimally suited for most pipettes
- ▶ Optimal water resistance and accuracy
- ▶ A little pressure needed for the tip inclusion and ejection
- ▶ Greatly reduce the muscle fatigue of the operator
- ▶ Can be used in plastic racks or in cardboard E-DEK- bio-degradable racks
- ▶ Guarantee an optimal load in terms of use with multichannel pipettes
- ▶ Cardboard rack particularly resistant to prevent use crush
- ▶ The OneTouch racked without filter tip are autoclavable
- ▶ A revolutionary packaging: E.DEK cardboard rack to reduce quantity of plastic waste



Tip without filter	Rack in Plastic		Rack in Carton E.DEK	
Tip	CAT. NO.	Units / Case	CAT. NO.	Units / Case
10/20 µl non sterile	010300	10 x 96	-	-
10/20 µl sterile	010310	10 x 96	010390	50 x 96
300 µl non sterile	010330	10 x 96	-	-
300 µl sterile	010340	10 x 96	010410	50 x 96
1000 µl non sterile	010360	8 x 96	-	-
1000 µl sterile	010370	8 x 96	-	-

Tip with filter	Rack in Plastic		Rack in Carton E.DEK	
Tip	CAT. NO.	Units / Case	CAT. NO.	Units / Case
10/20 µl with filter, sterile	010320	10 x 96	010400	10 x 96
100 µl with filter, sterile	010510	10 x 96	-	-
300 µl with filter, sterile	010350	10 x 96	010420	10 x 96
1000 µl with filter, sterile	010380	8 x 96	010460 010450	8 x 96 12 x 64



## MULTI SORENSON ONE TOUCH PIPETTES

Precision micropipette, with a shock absorption system on the piston and a double volume adjustment.

- ▶ Less effort to load and eject tips
- ▶ Volume adjustable with one hand
- ▶ Fully autoclavable
- ▶ The One Touch Pipette is the ideal pipette for the One Touch Multi tips, but also perfectly suitable to any other tip brands

CAT. NO.	Description	Sale unit.
112740	One Touch pipette- single channel, 0.5 - 10 µl Multi	1
112750	One Touch pipette- single channel, 2 - 20 µl Multi	1
112760	One Touch pipette- single channel, 2 - 20 µl long ejector Multi	1
112770	One Touch pipette- single channel, 10 - 100 µl Multi	1
112780	One Touch pipette- single channel, 20 - 200 µl Multi	1
112790	One Touch pipette- single channel, 100 - 1000 µl Multi	1





## PASTEUR PIPETTES



Single use transfer pipettes suitable for the vast majority of liquid handling in the laboratory. The integrated bulb contributes to a greater user safety. Our pipettes meet the requirements of routine work and those of more specific ones both.

- ▶ Graduated
- ▶ Flexible and non toxic polyethylene
- ▶ Available sterile and non
- ▶ Sterile, single packed or peel pack / 5 pcs
- ▶ Non toxic polyethylene

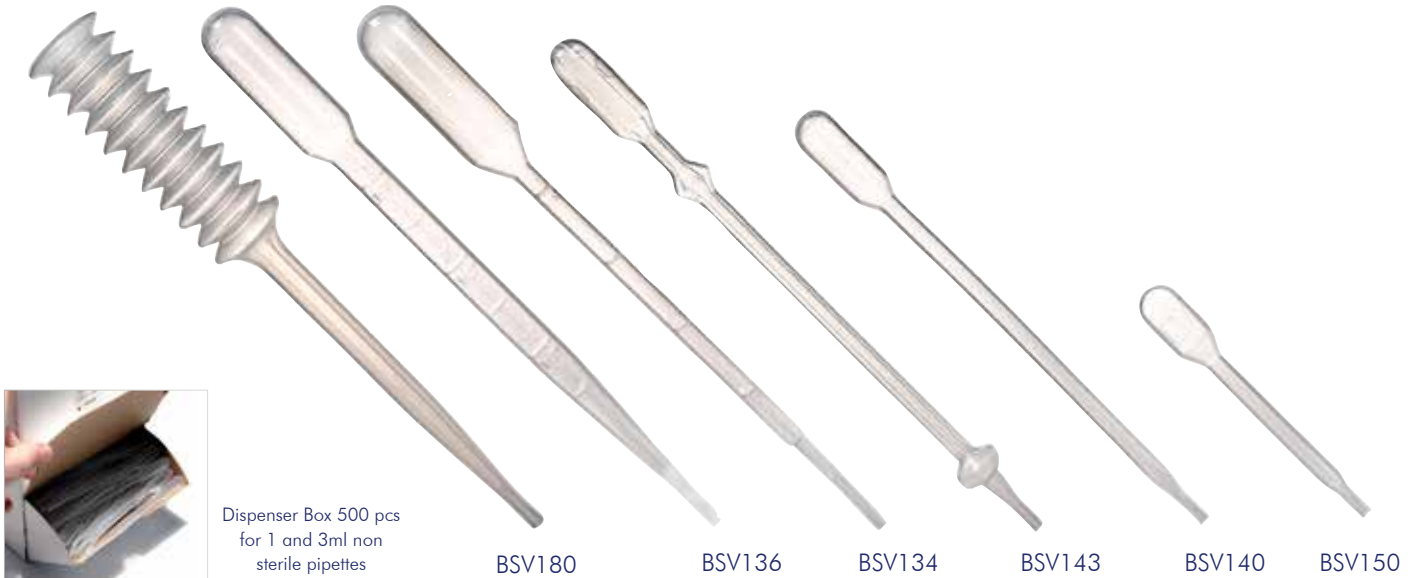

P.S. Volumes are only indicative. These devices have no primary-function of analytic measuring

### Pasteur pipette: non sterile

CAT. NO.	BSV180	BSV136	BSV134	BSV143	BSV140	BSV150
Description	Pasteur Pipette 10 ml	3 ml Graduated	1 ml Graduated	For M-T Kit	For Fast Read kit	For Card Test
Length mm	160	160	160	148	125	70
Graduation ml	-	0.5	0.25	-	-	-
Bulb draw ml	1	3.5	3.5	1	1	1
Drop vol. µl	50	40	40	40	40	40
Internal packaging	6 dispenser of 250 pcs	6 dispenser of 500 pcs	6 dispenser of 500 pcs	6 bags of 500 pcs	6 bags of 1000 pcs	1 bags of 10000
Sale unit	case / 1500	case / 3000	case / 3000	case / 3000	case / 6000	case / 10000

### Pasteur pipette: sterile, 1 and 3 ml

CAT. NO.	BSV135	BSV1351	BSV137	BSV1371
Description	1 ml Graduated	1 ml Graduated	3 ml Graduated	3 ml Graduated
Length mm	160	160	160	160
Graduation ml	0.25	0.25	0.5	0.5
Bulb draw ml	3.5	3.5	3.5	3.5
Internal packaging	peel pack of 5 pcs	individual peel pack	peel pack of 5 pcs	individual peel pack
Sale unit	case / 1000	case / 1000	case / 1000	case / 1000



Peel pack of 5 pcs



Individual peel pack



## INSTRUMENTATION PRODUCTS

*For more details please visit:*

<http://www.biosigma.com/instrumentation-products.html>

Biosigma is a world leader manufacturer of optical multisample cuvettes and cups utilizable in the most common clinical chemistry analyzers like as Hitachi, Cobas, Axsym, Express 500 and plus and others.

Made of high quality and transparency raw material, they are appositely studied to resist to washing solutions.

Our internal laboratory provides to test the cuvettes during production with the relevant chemistry analyzers.

# INSTRUMENTATION PRODUCTS

## CUVETTES AND CUPS UTILIZABLE ON COBAS®



Cuvettes in methacrylate, 12-cell available, single packed for handling and loading or in rack of 15 pcs for automatic loading



BSA84



BSA85



Microtube in PE utilizable on Cobas®

CAT. NO.	Color	Internal packaging	Sale unit
BSA024	neutral	bag / 500	case / 10000
BSA024/BLU	blue	bag / 1000	case / 12000
BSA024/G	yellow	bag / 1000	case / 12000
BSA024/RA	pink	bag / 1000	case / 12000
BSA024/V	green	bag / 1000	case / 12000

Cuvette

CAT. NO.	Internal packaging	Sale unit
BSA84	Single packed / 50	500
BSA85	30 racks of 15 pcs	450

Cobas® and Integra® are registered trade marks by ROCHE DIAGNOSTICS

## CUVETTES AND CUPS UTILIZABLE ON HITACHI®



HITACHI® is a registered trade mark by HITACHI JAPAN



Cuvette utilizable on HITACHI® 902 in bionex

CAT. NO.	Internal packaging	Sale unit
BSA094	6 sectors of 8 cells	24 (4 sets of 6 sectors)



Polystyrene sample cup utilizable on HITACHI® vol. 3ml

CAT. NO.	Dimensions	Internal packaging	Sale unit
BSA031S	H 3.81 Ø1.21 cm, Ø1.70 (max)	bag / 250	case / 6000



Cuvette utilizable on HITACHI® 911/912 in bionex

CAT. NO.	Internal packaging	Sale unit
BSA098	6 sectors of 20 cells	24 (4 sets of 6 sectors)



Bionex single cuvette

CAT. NO.	Dimensions	Sale unit
BSA108	H 2.80 L 0.79 P 0.62 cm	Rack 200 pcs



Cuvette utilizable on HITACHI® 717/914 in methacrylate

CAT. NO.	Internal packaging	Sale unit
BSA096	6 sectors of 20 cells	24 (4 sets of 6 sectors)



Pediatric sample cup utilizable on Hitachi®, Elecsys®, Cobas Integra® and Core®

CAT. NO.	Dimensions	Internal packaging	Sale unit
BSA86	H 3.72 cm, Ø 0,90 cm (Ø max 1,67; Ø bottom 1,23 cm)	500 / bag	5000 / case

## 12 CELLS CUVETTE



12-cell cuvette in Methacrylate. Carton of 30 racks supplied with 2 pliers. Plier is needed to transfer the cuvettes from the rack into the analyzer. Cuvette : H 2.00 L 5.20 D 0.86 cm



12 cells cuvettes

CAT. NO.	Internal packaging	Sale unit
BSP300	rack of 30 pcs	900 / case



Polystyrene sample cup: vol. 1.5 ml

CAT. NO.	Dimensions (cm)	Internal packaging	Sale unit
BSA027	H 2.30 Ø 1.36	bag / 1000	case / 10000

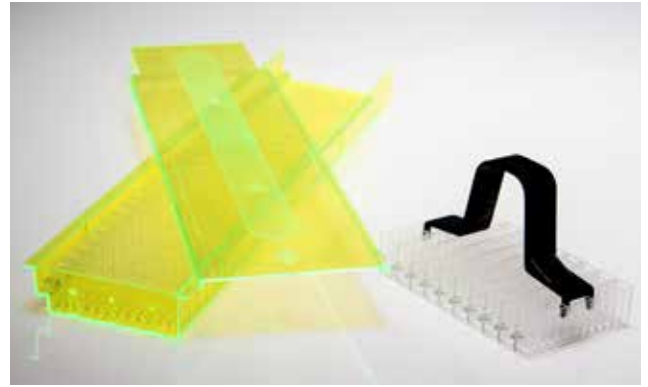

## CUVETTES UTILIZABLE ON EXPRESS®



5-cell cuvette in rack of 13 pcs supplied with or without orange waste bags, utilizable on EXPRESS® 550 and PLUS.

Optic multisample cuvettes utilizable on EXPRESS® 550 and PLUS + 24 bags

CAT. NO.	Internal packaging	Sale unit
BSA656	Rack of 13 pcs	case / 100 racks + 24 waste bags
BSA655	Rack of 13 pcs	case / 200 racks

CEX sample cup utilizable on express® 550 and plus in polystyrene.

CAT. NO.	Dimensions	Internal packaging	Sale unit
BSA658	H 1.91 ø 1.25 cm	1000 / bag	12000 / case

CEX pediatric cup utilizable on express® 550 and plus in polystyrene.

CAT. NO.	Dimensions	Internal packaging	Sale unit
BSA659	H 1.91 Ø 1.25 cm	1000 / bag	12000 / case



BSA658



BSA659

EXPRESS® is a registered trade marks by Bayer

## SAMPLE AND COAGULATION CUPS



- ▶ Made of high quality and transparent raw materials
- ▶ Tested in process with relevant analyzers

Sample cup utilizable on Olympus AU400/ AU640, in polystyrene



CAT. NO.	Dimensions (cm)	Internal packaging	Sale unit
BSA651	H 4.90 Ø 1.37 (max Ø 1.54)	bag / 1000	case / 3000

Coagulation sample cup with optagonal top profile, in polystyrene



CAT. NO.	Dimensions (cm)	Internal packaging	Sale unit
BSA5258	H 2.90 Ø 0.80	bag / 1000	case / 12000

Sample cup utilizable on Axsym in polystyrene



CAT. NO.	Dimensions (cm)	Internal packaging	Sale unit
BSA046	H 5.30 Ø 1.18, Ø 1.74(max)	bag / 1000	case / 4000

Coagulation cup, utilizable on ACCU COA DATA with metallic steel stick aside, in polystyrene



CAT. NO.	Dimensions (cm)	Internal packaging	Sale unit
BSA74	H 3.51 Ø 0.86	bag / 1000	case / 5000

Sample cup utilizable on TECHNICON Vol. 4 ml, in polystyrene



CAT. NO.	Dimensions (cm)	Internal packaging	Sale unit
BSA045	H 3.78 Ø 1.53	bag / 500	case / 5000

Coagulation cup utilizable on SEAC CLOT 2 with metallic steel stick, in polystyrene



CAT. NO.	Dimensions (cm)	Internal packaging	Sale unit
BSA77	H 3.47 Ø 1.34(max)	rack / 100	case / 1000

Sample cup utilizable on CENTRICHEM vol. 0.25 ml, in polystyrene



CAT. NO.	Dimensions (cm)	Internal packaging	Sale unit
BSA029	H 1.62 Ø 1.36	bag / 1000	case / 10000

Sample cup utilizable on Biotechnica Apparatus, in polypropylene



CAT. NO.	Dimensions (cm)	Internal packaging	Sale unit
BSA69	H 2.00 Ø 1.08	bag / 2000	case / 20000

Sample cup utilizable on TECHNICON vol. 1.5 ml, in polystyrene



CAT. NO.	Dimensions (cm)	Internal packaging	Sale unit
BSA027	H 2.30 Ø 1.36	bag / 1000	case / 10000

Cuvette utilizable on FIBRINTIMER with metallic mixers aside, in polystyrene



CAT. NO.	Dimensions (cm)	Internal packaging	Sale unit
BSA032	H 3.45 Ø 1.16	bag / 500	case / 10000

Sample cup utilizable on GENSEAC vol. 0.5 ml, in polystyrene



CAT. NO.	Dimensions (cm)	Internal packaging	Sale unit
BSA030	H 2.43 Ø 1.36	bag / 1000	case / 10000

Coagulation cup utilizable on Coag-Mat, in polystyrene



CAT. NO.	Dimensions (cm)	Internal packaging	Sale unit
BSA102	H 2.34 Ø 1.00	bag / 1000	case / 5000

Coagulation cup utilizable on Option, Benk, Trombotimer, in polystyrene



CAT. NO.	Dimensions (cm)	Metallic Mixers aside	Internal pack.	External pack.
BSA73	H 2.24 Ø 0.86		bag / 1000	case / 5000
BSA731	H 2.24 Ø 0.86	X	bag / 1000	case / 5000

Sample cup in PP utilizable on A.A.



CAT. NO.	Dimensions (cm)	Volume (ml)	Internal packaging	Sale unit
BSA88	H 4,9 Ø 1,98	2	500	5000

Axsym® is a registered trade mark by Abbott. Sismex® is a registered trade mark by Sismex Japan

## EASY NEST CUPS



Easy nest cups used as reducers of Ø 13 and 16 mm test tubes

Nesting sample cup

CAT. NO.	Volume (ml)	Diameter (mm)	Dimensions (cm)	Internal packaging	Sale unit
BSA636S	1	13	H 2.97 Ø 0.94 (max Ø 1.38)	500 / bag	10000 / case
BSA646S	2	16	H 2.97 Ø 1.24 (max 1.67)	1000 / bag	8000 / case



BSA646S



BSA636S

## SEMI-MICRO AND MACRO CUVETTES

Disposable spectrophotometer cuvettes in PS and PMMA



Plastic disposable cuvettes replacing fragile glass or quartz cuvettes in many applications that were previously beyond the range of plastic cuvettes. Designed for single use, they eliminate time-wasting washing, and the cross-contamination risk associated with washing and reusing cuvettes.

- ▶ Glass clear polystyrene or methacrylate
- ▶ Optimal results on both transmittance and absorbance tests compared with the most known brands in the market
- ▶ Applicable wavelength range 340 to 900 nm (PS) and 300 to 900 nm (PMMA)
- ▶ Path length 10 mm
- ▶ Maximum variability between the two walls of the same cuvette: <1%
- ▶ Direction arrow helping the correct insertion in spectrophotometer housings
- ▶ Ideal for determination of purity and concentration of proteins, DNA and RNA
- ▶ Will fit most commercial photometers without need for adapters
- ▶ Very high chemical resistance
- ▶ CE marked



### Macro



BSA001/BSA001M

Macro Cuvettes, volume 4 ml

CAT. NO.	Raw material	Dimensions (mm)	Internal packaging	Sale unit
BSA001	Polystyrene (PS)	12.5 x 12.5 x 45	rack / 100	1000
BSA001M	Methacrylate (PMMA)	12.5 x 12.5 x 45	rack / 100	1000

### Semi-micro

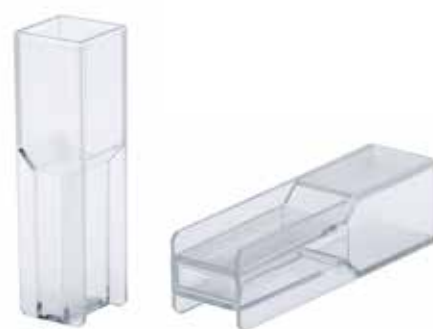

BSA002/BSA002M

Semi-Micro Cuvettes, volume 2 ml

CAT. NO.	Raw material	Dimensions (mm)	Internal packaging	Sale unit
BSA002	Polystyrene (PS)	12 x 6 x 45	rack / 100	1000
BSA002M	Methacrylate (PMMA)	12 x 6 x 45	rack / 100	1000

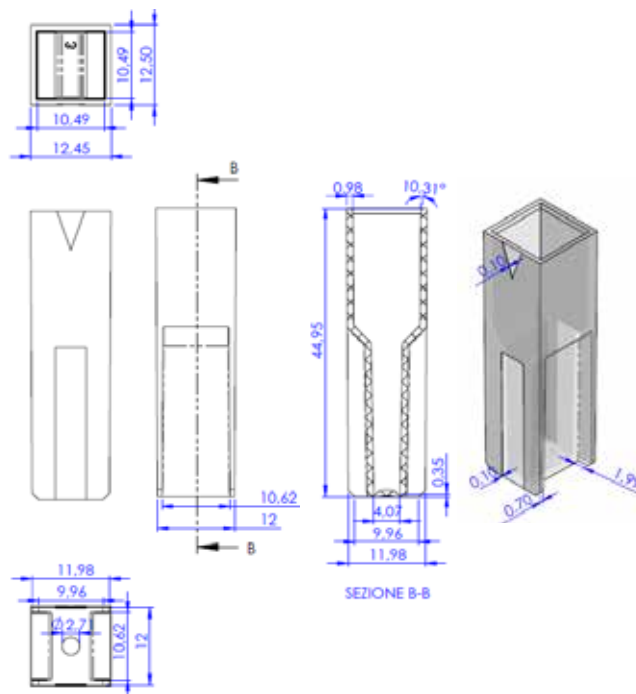
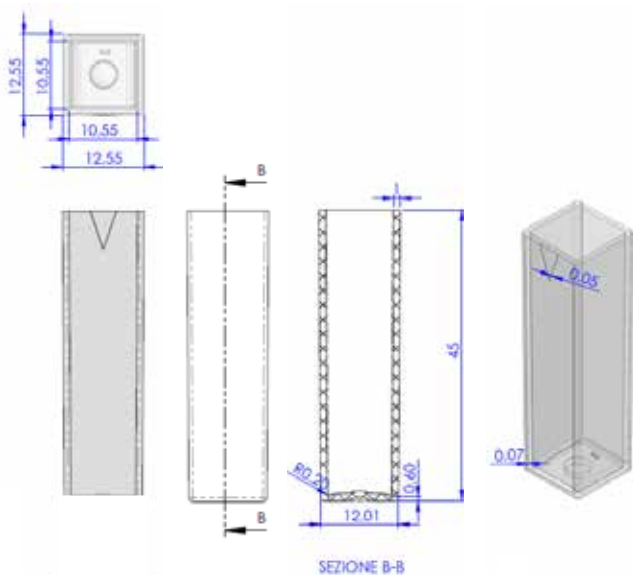

## Cuvettes transmittance

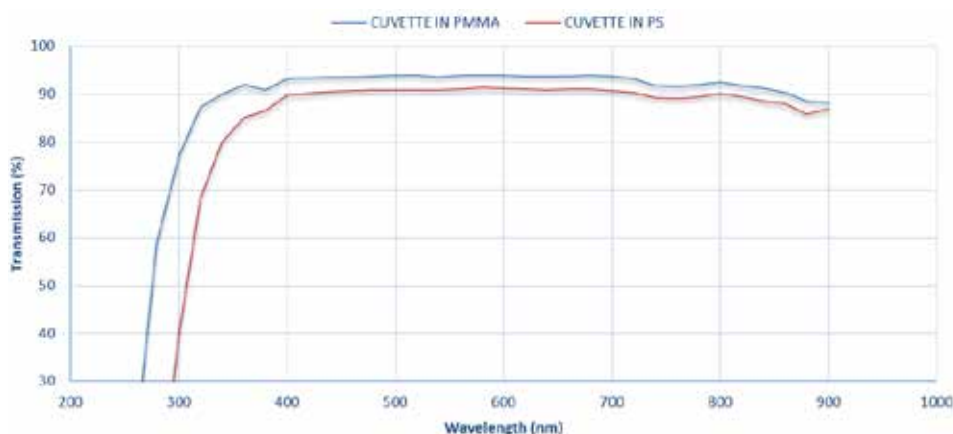

Raw material	Polystyrene (PS)	Methacrylate (PMMA)
Applicable wavelength range	340-900 nm	300-900 nm
Minimum transmittance %	from 80% to 90%, between 340 and 800 nm	from 80% to 94%, between 300 and 800 nm
Maximum transmittance variability of cuvettes coming from the same box	1,6%	1,6%



- ▶ Packed in smart polyfoam boxes of 100 units
- ▶ Automatic packaging
- ▶ Innovative box shape allows an easy handling of cuvettes
- ▶ Grouped by mold cavity number. Single-cavity boxes grants the best repetitiveness for the cuvettes of the same box\*\*

\*\* A plastic injection mold with 4 separate cavities can produce 4 cuvettes at a time. Minor dimensional variations between the cavities are unavoidable despite the most advanced technology. This may result in a greater variation of extinction values between cuvettes from different cavities. Therefore, cuvettes originating from the same cavity are automatically packaged into the same carton. For best results, use cuvettes from the same cavity number for each series of analyses.

## Quartz or Optical Glass Macro and Semi-Micro cuvettes

Quartz or Optical Glass Macro and Semi-Micro cuvettes for spectrophotometry

- ▶ Optical path 10 mm
- ▶ Each cell type is supplied in cartons of 2 pieces with Teflon lid

Raw material	Optical Glass	Quartz
Applicable wavelength range	320 – 2500 nm	190 – 2500 nm
Transmittance	350 nm ~ 82%	200 nm ~ 82%



BSA301



BSA303



BSA305



### Quartz or Optical Glass Macro and Semi-Micro cuvettes

CAT. NO.	Type	Raw material	Volume (ml)	Dimensions (cm)	Internal packaging	Sale unit
BSA300	Macro + lid	Optical Glass	3.5	45 x 12.5 x 12.5	2	1
BSA301	Macro + lid	Quartz	3.5		2	1
BSA302	Semi-Micro with sandblasted walls + lid	Optical Glass	1.4		2	1
BSA303	Semi-Micro with sandblasted walls + lid	Quartz	1.4		2	1
BSA304	Semi-Micro with black walls + lid	Optical Glass	1.4		2	1
BSA305	Semi-Micro with black walls + lid	Quartz	1.4		2	1



## URINE READING SYSTEM

For more details please visit:

<http://www.biosigma.com/urine-reading-system.html>



# URINE READING SYSTEM

## FOR THE STANDARDIZATION OF MICROSCOPIC URINALYSIS

The FAST READ 102® system improves the standardization of microscopic urinalysis and provides precision and reproducibility to guarantee constant readings which will not be influenced by variations of techniques among different operators.

FAST READ 102® is made of a slide which is protected by an optically transparent film, with 10 independent chambers containing a standard volume of 7  $\mu$ L. After dispensing the sample on the slide application area and thanks to a capillary mechanism, the sediment becomes homogeneously distributed in the reading chamber. Each chamber is fitted with its own system for the collection of excess urine to prevent any possible contamination. Furthermore FAST READ 102® slide allows easy identification of the sample by using the numbers printed on the sides.

**MATERIALS:** The BVS100 device is manufactured in METHACRYLATE: rigid, transparent, resistant to atmospheric agents, it replaces the glass in every its applications reaching high temperatures (lower than 90-100 °C).

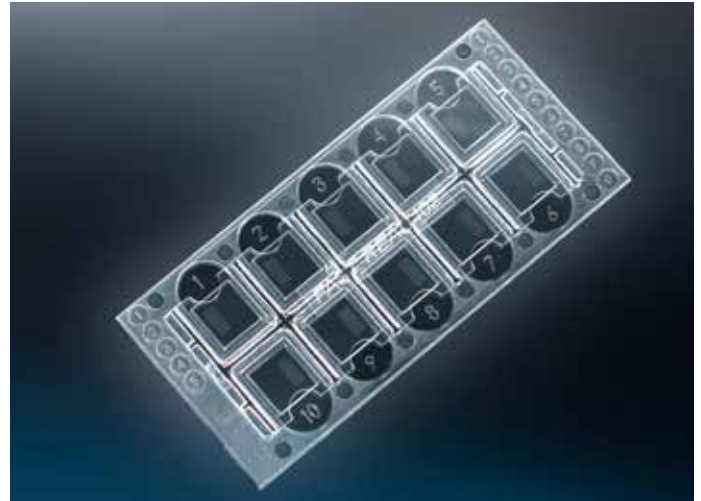

This product fulfils the requirements of Directive 98/79/EC on in vitro diagnostic medical devices

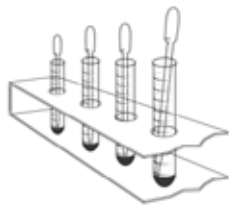

After completing the preparation of the urinary sediment by normal centrifugation, insert a pipette into the test tube and dispense one drop of STAIN.

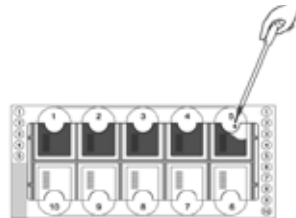

Use the pipette to mix the urinary sediment by repeatedly pressing the bulb; then dispense a drop of sample onto the appropriate area of the slide.

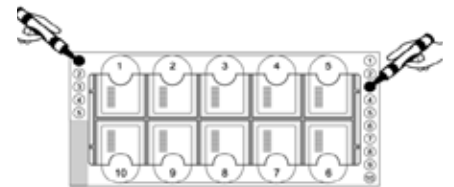

**HOW TO USE THE NUMBERING SYSTEM**  
Example: For the identification of samples from number 131 to 140 mark number 1 on the left side and number 3 on the right side of the slide.

## M-T system

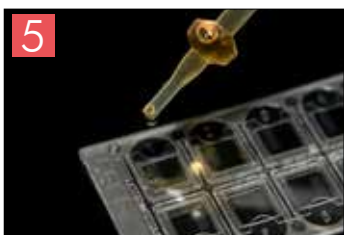
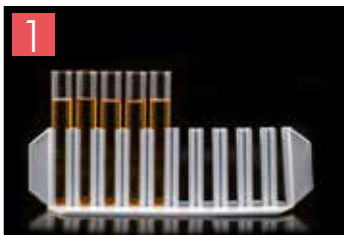

Test Tube 10ml  
BSP074

M-T microtips®  
BSV143

During urine sedimentation count it is very important using always the same sample preparation method in order to have tests' repeatability.

With traditional urine reading system, actually used by many laboratories, sedimentation compaction creates a superimposition of epithelial cells causing difficulties in verifying the presence amount of different cells components.

With Biosigma M-T System it is possible to overcome those inconveniences in a few standardisation steps during sample preparation.

1. Fill BSP074 test tubes with 10ml of urine and then centrifuge
2. Insert tribulb M-T Microtips® BSV143 making sure to trap the tubes
3. Overturn the rack for the excess urine
4. You will get 1 ml of sediment, resuspended and ready to be analysed on Fast Read 102® Slides
5. Deposit a drop in the Fast Read 102® cell



M-T microtips® is a Biosigma's registered trade marks

# URINE READING SYSTEM

## CALCULATION METHOD FOR CELLS / $\mu\text{L}$ IN URINARY SEDIMENT

FAST READ 102® is a disposable plastic device composed of 10 counting chambers. Each device allow to analyze 10 samples. Each room contains a GRID composed of 10 SQUARES divided into 16 smaller squares (called SECTORS). One advantage of using FAST-READ is to determine easily the specimen's number of cells per  $\mu\text{L}$

1. Perform the count on a centrifuged fresh urine sample, after decantation
2. Gently resuspend the sediment
3. Using a pipette, introduce the sample into the well and examine under the microscope the area of the grid
4. Count the number of cellular elements within N squares

$$\text{Cell. / } \mu\text{l} = \frac{(\sum \text{ cells counted in square N}) \times \text{concentration factor} \times 10}{N}$$

Concentration factor = Volume of sediment / Volume centrifuged urine  
10: conversion from 0.1  $\mu\text{l}$  to 1  $\mu\text{l}$

For uncentrifuged urine, don't multiply the number of cells counted for the concentration factor.

## METHOD OF CELL COUNTS FOR DILUTED SAMPLES (CELLS / ML)

After filling the counting chamber with the sample, proceed with the counting of the cells distributed in N squares. Considering that the grid consists of 10 squares, each square has a Dimensions of 1 x 1 mm, a depth of 0.1 mm and a volume of 0.1  $\mu\text{l}$ , the formula for determining the concentration of cells (cells / ml) is:

$$\text{Cells / ml} = \frac{(\sum \text{ cells counted in square N}) \times \text{dilution factor} \times 10^4}{N}$$

$10^4$  = conversion 0.1  $\mu\text{l}$  in 1 ml

Pay attention to the cells on the edges, you should only count those on either side, to avoid over or under counting risk.

In the example shows, we perform the cell counting of a sample diluted 100 times:  
N = 5 (number of squares considered for counting) cells counted in 5 square = 67  
Dilution factor =  $10^2$   
[Cells / ml] =  $(67/5) \times 10^2 \times 10^4 = 13.4 \times 10^6$

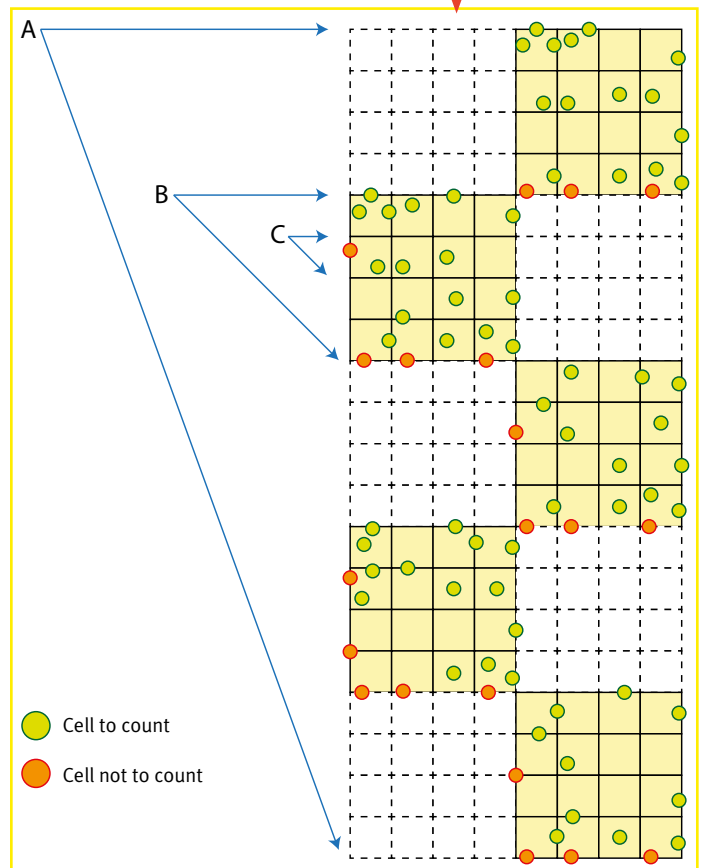
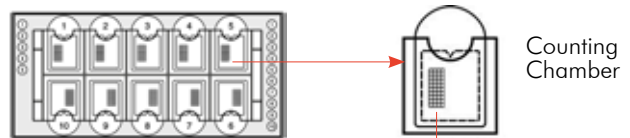

A: GRID	
Dimensions	2 mm x 5 mm
Depth	0.1 mm
Volume	1 $\mu\text{l}$
Each grid includes	10 squares
Cell volume	7 $\mu\text{l}$
B: SQUARE	
Dimensions	1 mm x 1 mm
Depth	0.1 mm
Volume	1 $\mu\text{l}$
Each square includes	16 sector
C: SECTOR	
Dimensions	0.25 mm x 0.25 mm
Depth	0.1 mm
Volume of sector	0.00625 $\mu\text{l}$



Publication in scientific journal.

Validation of analytical methods in GMP: the disposable Fast Read 102® device, an alternative practical approach for cell counting.

Gunetti M, Castiglia S, Rustichelli D, Mareschi K, Sanavio F, Muraro M, Signorino E, Castello L, Ferrero I, Fagioli F.  
J.Transl Med. 2012 May 31;10:112  
[www.Translational-medicine.com/content/10/1/112](http://www.Translational-medicine.com/content/10/1/112)

# URINE READING SYSTEM



## How to order FAST-READ® kits

1 kit = 1.000 determinations

	Fast-Read® 102	M-T Microtips®	Pasteur Pipette in PE	Test Tube 10 ml in PS	White Cap aside	Test Tube 10 ml in PS labelled with white cap	Stain urinary sediment
	(BVS100)	(BVS143)	(BVS140)	(BSP074)	(BSO026)	(BSP112)	(BVS135)
<b>CAT. NO.</b>							
BVS100	●						
BVS101	●		●				
BVS102	●		●				●
BVS190		●		●			
BVS171	●	●					
BVS1715	●	●		●			
BVS1719	●	●		●	●		
BVS1717	●	●		●			●
BVS1720	●	●		●	●		●
BVS1721	●	●				●	●

## Urinalysis controls validate performance for consistency and accuracy

### KOVA® Urinalysis Controls Validate Performance for Consistency and Accuracy

For quality control, use KOVA controls to validate the performance of urine chemistry test strips and readers and to help focus microscopic sediment analysis.

KOVA Liqua-Trol™ is a ready-to-use bi-level liquid control for use with all major brands of urine chemistry dipsticks.

### KOVA® Liqua-Trol™

Ready-to-use liquid control.

External quality control of physical, chemical and microscopic examination of urine specimens. Available with or without microscopic. Two levels of controls to monitor complete decision range for urine strip chemistries.

Value assignments available on all major systems for visual and instrument analysis.

Stability: 30 days at room temperature and up to 27 months shelf life for the full labeled dating when stored in a refrigerator (2-8°C).



### Individual and Combination Packs

CAT. NO.	Description	Bottle (ml)	Scale unit
87112E	KOVA Liqua-Trol Level I (Abnormal) and Level II (Normal w/ hCG); bi-level 3x15mL	15	6
87122E	KOVA Liqua-Trol Level II (Normal) with hCG and microscopics	120	2
87176E	KOVA Liqua-Trol Level I (Abnormal) with microscopics	120	2
87123E	KOVA Liqua-Trol Level II (Normal) with hCG and microscopics	120	4
87177E	KOVA Liqua-Trol Level I (Abnormal) with microscopics	120	4

## STAN-TAP & STAN-TAP SYSTEM



The STAN-TAP is a supplementary device to FAST-READ®

The standardization of urinary sediment analysis can now be simpler and more accurate. It is important that the examination of the sediment is carried out always following the same procedures in order to guarantee the repeatability of the test, which is difficult to obtain with the traditional system currently used in many laboratories. Furthermore, the compaction of the urinary sediment creates an overlap of epithelial cells making it difficult to verify the presence of other cellular elements.

System CE Mark IVD according to Dir.98 / 79 / CE and ss.mm.ii.

**Advantages:** The STAN-TAP allows rapid and repeatable preparation of the urinary sediment sample for microscopic analysis.



CAT. NO.	Description	Stan Tap	Test Tube 10 ml (BSP074)
BVS172	cap only	●	
BVS174	cap with tube aside	●	●



### BVS174 INSTRUCTIONS FOR USE (cap with tube aside)

**1.** Fill the tube with the urine up to the level indicated by the maximum graduation on the tube (10 ml)



**2.** Centrifuge

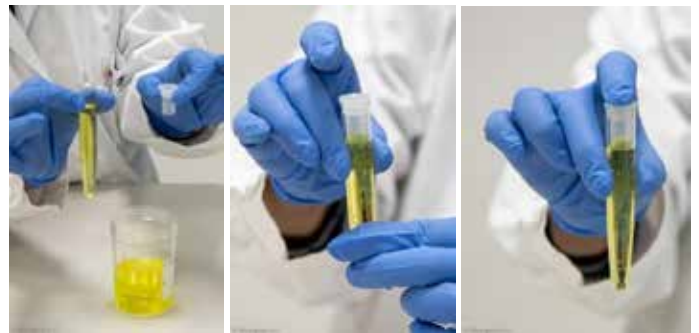

**3.** Insert the Stan-Tap by exerting slight pressure to allow it to fit into the tube.

**4.** Decant excess urine by rapidly inverting the tube (by rotating 180°). The sediment and urine residue up to 1 ml will remain in the tube and will be retained in the gap between the tube and the Stan-Tap.

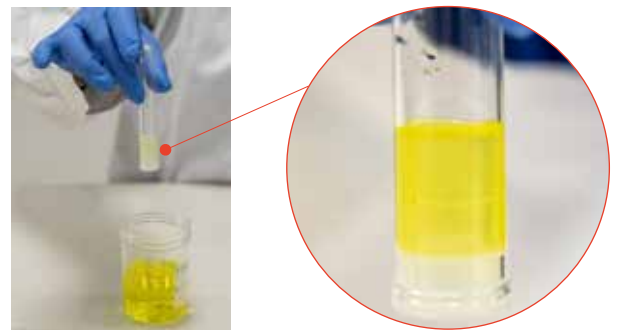

**5.** Bring the tube into a vertical position by rotating it 180°. Resuspend the sediment and proceed to the analysis.

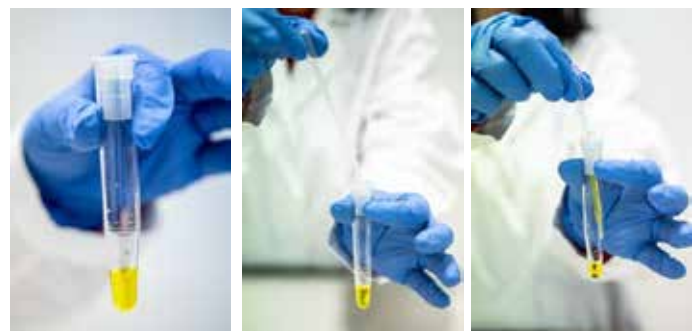

## ASSEMBLED STAN-TAP SYSTEM

CE IVD

Integrated system for the standardized preparation of the urinary sediment

The standardization of urinary sediment analysis can now be simpler and more accurate. It is important that the examination of the sediment is carried out always following the same procedures in order to guarantee the repeatability of the test, which is difficult to obtain with the traditional system currently used in many laboratories. Furthermore, the compaction of the urinary sediment creates an overlap of epithelial cells making it difficult to verify the presence of other cellular elements.

System CE Mark IVD according to Dir.98 / 79 / CE and ss.mm.ii.

**Advantages:** The ASSEMBLED STAN-TAP SYSTEM allows rapid and repeatable preparation of the urinary sediment sample for microscopic analysis

CAT. NO.	Description	Stan Tap	Test Tube 10 ml (BSP074)
BVS1741	cap with tube assembled	●	●



### BVS1741 INSTRUCTIONS FOR USE (cap with tube assembled)

**1.** Fill the tube with the urine up to the level indicated in the STAN-TAP (corresponding to 10 ml)

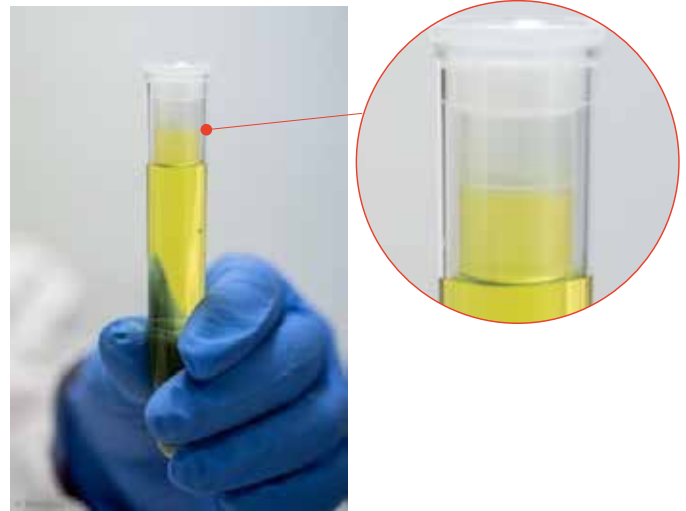

**2.** Centrifuge

**3.** Decant excess urine by rapidly inverting the tube (by rotating 180°). The sediment and urine residue up to 1 ml will remain in the tube and will be retained in the gap between the tube and the Stan-Tap.

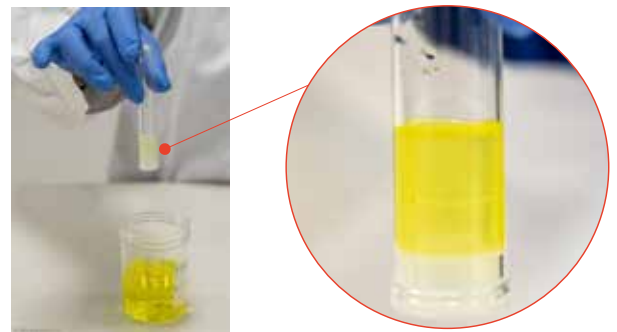

**4.** Bring the tube into a vertical position by rotating it 180°. Resuspend the sediment and proceed to the analysis.

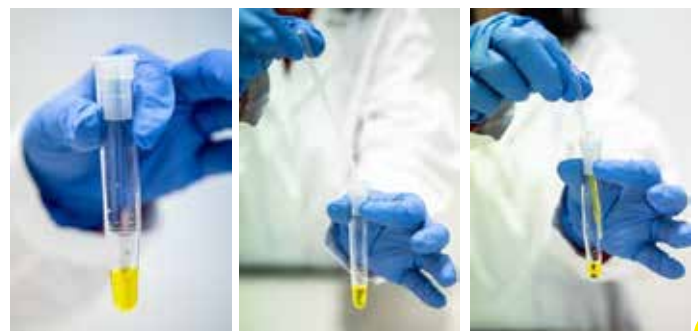



# HISTOLOGY AND MICROSCOPY

For more details please visit:

<http://www.biosigma.com/histology-and-microscopy.html>

A wide range of products to Histology disposables like as Tissue Embedding and Biopsy cassettes with and without lid but also many other product to assist you to on transportation, storage and staining of microscope slides

## Embedding cassette w/out lid



Embedding cassette without lid designed to accept standard metal lids

CAT. NO.	Color	Int. pack	Sale unit
BSI104	white	500	2000

## Metal Lid



Metal Lid

CAT. NO.	Color	Int. pack	Sale unit
BSI220	Metal	10	20

## Embedding ring

- ▶ External dimensions: 28 x 24 x 10mm
- ▶ Internal dimensions: 14,20 x 14 x 10mm



Embedding ring

CAT. NO.	Color	Int. pack	Sale unit
BSI4401	white	1000	3000

## EMBEDDING CASSETTES

Embedding cassettes with removable cover, made of acetalic resin (POM), resistant to solvents, decalcificants, histological solutions and ultrasound techniques. Writing area for sample identifications. Also suitable to automatic printers

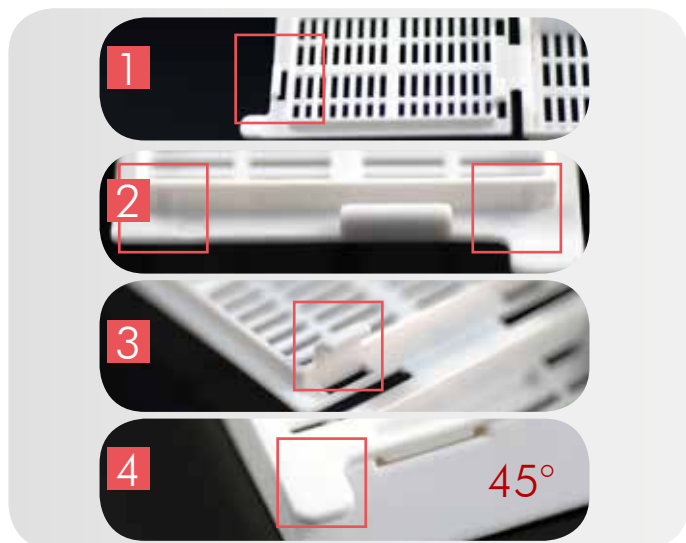

### Innovative closing system

A Biosigma innovative closing system to avoid the cassette's accidental opening during sample processing but of easy use anyway.

**Picture 1:** A hook closure insertion in the cassette front part avoids any accidental opening in case of voluminous sample.

**Picture 2:** The presence of a special ribbed lid fitted with 2 rear hooks (**Picture 3**) prevents the forward movement and the cassette's rear opening.

**Picture 4:** The opening tab does not present sharp edges and is structured to allow operator easy opening. Anterior writing area at 45° angle.

### Histology cassettes



Cassette in Pom detachable cover (40x28x7mm) with rettangular holes (5x1 mm)

#### Histology cassette

CAT. NO.	Color	Internal packaging	Sale unit
BSI102	white	bag / 500	case / 2000
BSI1022	yellow	bag / 500	case / 2000
BSI1024	pink	bag / 500	case / 2000
BSI1026	green	bag / 500	case / 2000
BSI1027	orange	bag / 500	case / 2000
BSI1028	light blue	bag / 500	case / 2000

### Biopsy cassettes



Cassette in Pom detachable cover (40x28x7mm) with square holes (1x1 mm).

#### Biopsy cassette

CAT. NO.	Color	Internal packaging	Sale unit
BSI103	white	bag / 500	case / 2000
BSI1032	yellow	bag / 500	case / 2000
BSI1034	pink	bag / 500	case / 2000
BSI1036	green	bag / 500	case / 2000
BSI1037	orange	bag / 500	case / 2000
BSI1038	light blue	bag / 500	case / 2000

### Mould base stainless steel



#### Mould base stainless steel

CAT. NO.	Internal dimensions	CAT. NO.	Internal dimensions	Sale unit
040728	7 x 7 x 5 mm	040731	30 x 24 x 5 mm	12
040729	15 x 15 x 5 mm	040732	37 x 24 x 5 mm	12
040730	24 x 24 x 5 mm			12

### Histological sponge

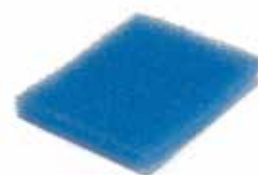

#### Histological sponge

CAT. NO.	Color	Internal packaging	Sale unit
BSI105	blue	500	5000

## MICROSCOPE SLIDES



- ▶ Particularly indicated for microscope analysis of blood, urine, tissue samples and other biological fluids for in vitro diagnostic analysis.
- ▶ Dimensions: 26 x 76 x 1.0-1.2 mm
- ▶ Thickness tolerances: 1.1 ± 0.1 mm
- ▶ Transparent glass
- ▶ In conformity with international standards and ISO 8255-1 ISO 8037-1

### Microscope slides with paper

CAT. NO.	Dim (mm)	Corner	Cut edges	Ground edges	Frosted area	Int. pack.	Sale unit
VBS653/A	26 x 76	90°	X			50	2500
VBS654/A	26 x 76	90°	X		X	50	2500
VBS655/A	26 x 76	45°		X		50	2500

### Microscope slides without paper

CAT. NO.	Dim (mm)	Corner	Cut edges	Ground edges	Frosted area	Int. pack.	Sale unit
VBS653	26 x 76	90°	X			50	2500
VBS654	26 x 76	90°	X		X	50	2500
VBS655	26 x 76	45°		X		50	2500
VBS656	26 x 76	45°		X	X	50	2500

### Microscope slides color coded for easy identification

CAT. NO.	Dim (mm)	Corner	Colour	Ground edges	Frosted area	Int. pack.	Sale unit
VBS656/B	26 x 76	45°	white	X	X	50	2500
VBS656/AZ	26 x 76	45°	light blue	X	X	50	2500
VBS656/G	26 x 76	45°	yellow	X	X	50	2500
VBS656/RA	26 x 76	45°	pink	X	X	50	2500
VBS656/V	26 x 76	45°	green	X	X	50	2500
VBS656/AR	26 x 76	45°	orange	X	X	50	2500



Microscope slides with paper

Microscope slides without paper



## COVERSLIPS



- ▶ Particularly indicated for microscope analysis of blood, urine, tissue samples and other biological fluids for in vitro diagnostic analysis.
- ▶ Thickness: 0.13 ± 0.17 mm
- ▶ Transparent glass

### Coverslips

CAT. NO.	Dimensions (mm)	Thickness	Internal packaging	Sale unit
VBS633	18 x 18	0.13 ± 0.17 mm	200	2000
VBS634	20 x 20	0.13 ± 0.17 mm	200	2000
VBS636	22 x 22	0.13 ± 0.17 mm	200	2000
VBS637	24 x 24	0.13 ± 0.17 mm	200	2000
VBS638	24 x 32	0.13 ± 0.17 mm	100	1000
VBS649	24 x 40	0.13 ± 0.17 mm	100	1000
VBS650	24 x 50	0.13 ± 0.17 mm	100	1000
VBS651	24 x 60	0.13 ± 0.17 mm	100	1000



## HISTOBOND® TRADEMARK BY PAUL MARIENFELD

HistoBond® adhesive microscope slides with silane treated surfaces for effective adhesion of tissue sections, glass, with ground edges 90°, approx. 76x26 mm (DIN ISO 8037-1), thickness approx. 1 mm, twin frosted 20 mm (at one end, both sides).



### Histobond®

CAT. NO.	Dimensions (mm)	Internal packaging	Sale unit
VBS5001	76x26	100	2000

## COVERSLIPS FOR AUTOMATIC MACHINES

Such coverslips are made of pure white borosilicate glass, perfectly clear and chemically resistant to the first hydrolytic class. They are suitable for automatic machine. Thickness of 0.16 to 0.19 mm.



### Coverslips

CAT. NO.	Dimensions (mm)	Thickness	Internal packaging	Sale unit
VBS6502	24 x 50	0.16 to 0.19 mm	100	1000
VBS6512	24 x 60	0.16 to 0.19 mm	100	1000



## PLASTIC TRAYS AND SLIDES MAILERS

- ▶ In polypropylene
- ▶ Snap closure for perfect tightness,
- ▶ For 26x76mm slides



Slide mailer in polypropylene

CAT. NO.	Dimensions (mm)	Places	Internal packaging	Sale unit
BSL923	98.8 x 50.6 x 6.4	1	10	500
BSL925	70 x 84 x 6	2	10	500
BSL924	84 x 97 x 6	3	10	500

- ▶ In polypropylene
- ▶ 2 places
- ▶ For 26x76mm slides



Plastainer slides mailer

CAT. NO.	Places	Sale unit
BS1101	2	1000

- ▶ In polypropylene
- ▶ Screw cap
- ▶ From 5 to 10 places
- ▶ 40 x 90 mm
- ▶ For standard microscope with loop for sealing applications



Slide mailer screw cap

CAT. NO.	Dimensions (mm)	Places	Internal packaging	Sale unit
BSL922	40 x 90	From 5 to 10	50	250

- ▶ In polystyrene
- ▶ From 10 to 40 places
- ▶ White color
- ▶ For standard microscope slides 26 x 76 mm



Microscope slides trays

CAT. NO.	Dimensions (mm)	Places	Sale unit
BSL671	34.0 x 10.0	10	40
BSL672	34.0 x 19.0	20	20
BSL673	34.0 x 40.0	40	10

## STORAGE MICROSCOPE SLIDE BOXES

- ▶ In durable ABS raw material
- ▶ With numbered slots for 26x76mm slides
- ▶ Index-card for the classification
- ▶ Biohazard label on the top
- ▶ Hinged lid



Storage microscope slide boxes

CAT. NO.	Dimensions (mm)	Places	Sale unit
BSL274	3.0 x 5.0 x 8.0	12	15
BSL276	3.0 x 9.5 x 8.0	25	15
BSL277	3.0 x 8.0 x 20.0	50	15
BSL278	3.0 x 16.0 x 20.0	100	15

## SLIDE STORING SYSTEM

- ▶ Cabinet with 5 drawers for microscope slide storage
- ▶ Can take up to 5000 slides
- ▶ Each drawer can be completed with racks for 100 slides
- ▶ The rack itself is closed by a transparent lid
- ▶ The cabinet is supplied with the drawers, without the racks



Slide storing system

CAT. NO.	Description	Dimensions (mm)	Raw Material	Sale unit
BSL921	Storage rack 100 slides	360 x 38 x 100	PP	1
BSL920	Lid for rack	345 x 35 x 40	PS	1

## COPLIN STAINING JAR

A soda-lime glass jar with cap, Coplin type.

- ▶ For 5 slides -76x26mm (or 10 back-to-back slides)
- ▶  $\varnothing \times h = 73 \times 105$  mm



Coplin staining jar

CAT.NO.	Descriptions	Capacity	Sale Unit
068512	Coplin staining jar	5 slides 76x26 mm (or 10 back-to-back slides)	1

## SCHIFFERDECKER STAINING BOX

A soda-lime glass box with top, Schifferdecker type

- ▶ For 10 slides 76 x 26 mm (or 20 back-to-back slides)
- ▶ L x l x h: 90 x 70 x 50 mm



Schifferdecker staining box

CAT.NO.	Descriptions	Capacity	Sale Unit
068511	Schifferdecker staining box	For 10 slides 76x26 mm (or 20 back-to-back slides)	1

## HELLEDAHL STAINING JAR

A soda-lime glass jar with top, Hellendahl type.

- ▶ For 8 slides 76x26mm (or 16 back-to-back slides)
- ▶ L x l x h: 58.5 x 58.5 x 100 mm



Simple STAINING JAR, Helledahl type

CAT.NO.	Descriptions	Capacity	Sale Unit
068509	Helledahl staining jar	For 8 slides 76x26 mm (or 16 back-to-back slides)	1

## STAINING JAR WITH 2 LIDS

- ▶ PMP (TPX)
- ▶ Can be used with or without a polypropylene rack for 20 slides
- ▶ Opening lid which facilitates the use of the rack during the staining phases



Staining jar with 2 lids

CAT.NO.	Descriptions	L x w x h (mm)	Sale Unit
391057	Staining jar	81 x 101 x 70	1
391058	Holder for 20 slides	Rod height: 167 l x w: 70 x 86 (tank: 81 x 101)	1

## OILS FOR IMMERSIONS

The means of immersion for microscopy have the same glass index of refraction. Thanks to oil immersion, the deviation of the light rays is almost completely eliminated and the performance objectives of the microscopes are therefore considerably improved.



CAT.NO.	Descriptions	Sale Unit
BS1114	Oil for immersion, 100 ml	1

## EUKITT BALM FOR INCLUSIONS

- ▶ Early strenght
- ▶ Solidification in 20 minuts



CAT.NO.	Descriptions	Sale Unit
045798	Balm for inclusion - flacon of 100 ml	1
045799	Balm for inclusion - flacon of 250 ml	1

## COUNTING CHAMBER

- ▶ CE marked
- ▶ Products with special optical glass
- ▶ Tolerances of the depth of the chamber 2% (max)
- ▶ In compliance with DIN ISO 12847

### Dark line

The rooms of counts standards have grids counts engraved on the bottom of the chamber. Under the microscope the lines of the grid appear dark counts.

### Bright line

The rooms of counts "bright line" have grids counts etched in a thin layer of metal. The lines appear bright, in contrast with the dark metallic background, facilitating the evaluation of cell suspensions.

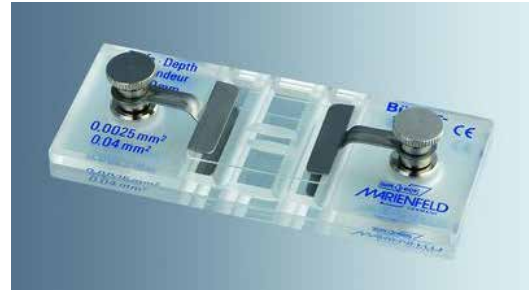

### Counting chamber

Codice	Chamber type	With pliers	Grid type	Sale Unit
900510	Burker	pliers standard	bright line	1
900514	Fuchs-Rosenthal	pliers standard	dark line	1
900509	Nageotte	pliers double	dark line	1
900511	Neubauer improved	pliers double	dark line	1
900512	Thoma Cell Rete	with clips	dark line	1

### Coverslip for counting chamber

Codice	For chamber	Dimensions (mm)	Thickness (mm)	Sale Unit
VBS626	Fuchs-Rosenthal	24 x 24	0.4	100
VBS627	Burker	21 x 23	0.4	100
VBS628	Neubauer	21 x 26	0.4	100
VBS629	Thoma Cell Rete	22 x 22	0.4	100
VBS630	Nageotte	30 x 30	0.4	100

## MEMBRANE IN PC

Membrane in PC 5.0  $\mu\text{m}$  19 x 42 x 100

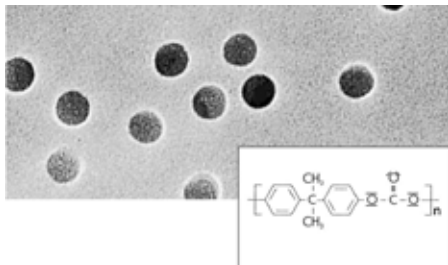

CAT.NO.	Descriptions	Sale Unit
036164	Membrane in PC 5.0 $\mu\text{m}$ 19 x 42 x 100	100

## POLYCARBONATE MEMBRANES

- ▶ Cut-offs from 0.05  $\mu\text{m}$  to 12  $\mu\text{m}$
- ▶ Non-sterile
- ▶ Diameter 13, 25, 37, 47 and 80 mm
- ▶ In boxes of 100



CAT.NO.	Descriptions	Sale Unit
321009	Polycarbonate membrane, filtration threshold 5 $\mu\text{m}$ , diameter 25 mm	100

## MAKLER CELL

Counting cell with predetermined depth to obtain a monolayer of spermatozoides.

- ▶ Coverslip with grid with 100 squares measuring 0.1 mm across
- ▶ 10  $\mu\text{m}$  space between the cell and the coverslip

### Makler cell

CAT.NO.	Descriptions	Sale Unit
000972	Makler counting chamber	1
000973	Grid with squares for Makler chamber	1





## MICROBIOLOGY

*For more details please visit:*

*<http://www.biosigma.com/microbiology.html>*

A wide choice of Microbiology products such as Petri dishes and inoculating loops, swabs, cell spreaders and a variety of centrifuge tubes

## INOCULATION LOOPS



Disposable loops 1 and 10  $\mu$ l, sterile, in polypropylene. One side is provided of loop head and the other side of inoculating needle. The easy peel-pack open pouch enables fast and easy access to the product especially when wearing latex gloves. Peel-pack shows lot no and sterility expiry date. Peel-pack can be of 5, 10, 20 units or single packed.

- ▶ In polypropylene
- ▶ 1 or 10  $\mu$ l
- ▶ Peel-pack

- ▶ Single, bag/5, Bag/10, Bag/20
- ▶ Sterile
- ▶ Lot No. and expiry date on each pack



10  $\mu$ l



### Inoculation loop: 10 $\mu$ l

CAT. NO.	Case	Color	Internal packaging	Sale unit
BSV120	peel pack of 20 pcs	blue	bag / 2000	case / 10000
BSV1200	peel pack of 10 pcs	blue	bag / 200	case / 12000
BSV1205	peel pack of 5 pcs	blue	bag / 500	case / 4000
BSV1201	single packed	blue	bag / 350	case / 2100



1  $\mu$ l



### Inoculation loop: 1 $\mu$ l

CAT. NO.	Case	Color	Internal packaging	Sale unit
BSV121	peel pack of 20 pcs	white	bag / 2000	case / 10000
BSV1210	peel pack of 10 pcs	white	bag / 200	case / 12000
BSV1215	peel pack of 5 pcs	white	bag / 500	case / 4000
BSV1211	single packed	white	bag / 350	case / 2100



## STERILE L-SHAPED SPREADERS

Sterile L-shaped spreader with a curved end to avoid scratching the culture surface

CAT. NO.	Description	Rake length (mm)	Internal Packaging	Sale unit
999060B	Sterile L-shape spreader with curved right elbow, white colour	35	1	400
999059B	Sterile L-shape spreader ø 3 mm with curved right elbow, white colour	35	5	400
042820	L-shape spreader with curved end, sterile, blue colour	33	1	500
042821	L-shape spreader with curved end, sterile, blue colour	34	5	1000



Sterile T-shaped spreader

CAT. NO.	Description	Rake length (mm)	Internal Packaging	Sale unit
042822	Sterile T-shape spreader single packed	35	single packed	500
042823	Sterile T-shape spreader (packs of 5)	35	packs of 5	1000
042824	Sterile T-shape spreader (packs of 10)	34	packs of 10	1000



Sterile rake shaped spreader, dimensions: 172 x 37 x 14 mm. Easy to handle

CAT. NO.	Description	dimensions (mm)	Internal Packaging	Sale unit
037877	Sterile Disposable spreader	172 x 37 x 14	single packed	500

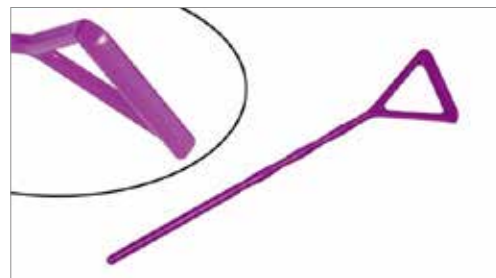

## PETRI DISHES

Disposable round petri dishes in transparent polystyrene, available sterile, not sterile, with and without vents for some specific automatic machines.

CAT. NO.	Ø mm	Ventilation	For autom. machines	Sterile	Internal packaging	Sale unit
BSM200	60			X	bag / 10	case / 1000
BSM212	90	X	X		bag / 20	case / 480
BSM2120	90	X	X	X	bag / 20	case / 480
BSM215	100	X		X	bag / 10	case / 500
BSM220	120			X	bag / 10	case / 320
BSM230	150	X		X	bag / 20	case / 220



- ▶ Made of crystal polystyrene, superior clarity
- ▶ Manufactured under aseptic ISO Class-7 conditions
- ▶ Aseptic
- ▶ Sub-packaged in plastic bags
- ▶ CE marking, as per EU Directive 98/79/EC
- ▶ Resin and packaging are free from heavy-metals, as per EC directive CE/94/62
- ▶ Suitable for food-contact, as per Regulation (EC) No 1935/2004
- ▶ Pouring-off temperature : 60°C

CAT. NO.	Description	Sale unit
076058	Petri dishes diam 55mm with ergot aseptic clearline	case / 1200
076059	Petri dishes diam 55mm without ergot aseptic clearline	case / 1200
076084B	Petri dishes diam 90mm with ergot s/s20 aseptic clearline	case / 500
076060B	Petri dishes diam 140mm with ergot aseptic clearline	case / 120

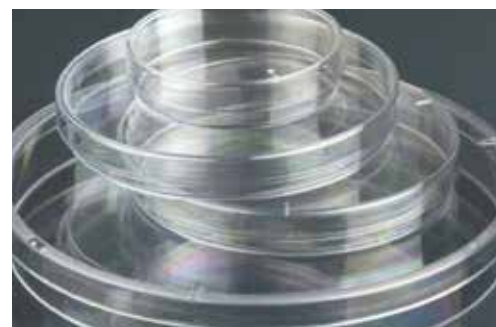

## SWABS

**Amies:** The medium allows good conservation of beta-hemolytic streptococcus, intestinal pathogenic and *S. aureus* for over 3 days, of *N. gonorrhoeae* for 24 hours, of *B. pertussis* and *Fusobacterium* for 48 - 72 hours.

**Amies with charcoal:** The medium allows good conservation of beta-hemolytic streptococci, intestinal pathogenic and *S. aureus* for over 3 days, of *N. gonorrhoeae* for 24 hours, of *B. pertussis* and *Fusobacterium* for 48 - 72 hours. The vegetable carbon present in the medium improves the survival of *Neisseria gonorrhoeae* and of the intestinal pathogenic bacteria neutralizing the toxic metabolic products.

**Stuart:** Stuart's preparation was designed to preserve *Neisseriae Gonorrhoeae* and *Trichomonas Vaginalis* without permitting their proliferation. The medium has been shown to be suitable for transporting *Haemophilus Influentiae*, *streptococcus Pyogenes*, *Corynebacterium Diptheriae*, *Enterobacteria* and *Bacteria* of the respiratory tract as well. *Bacteria* can survive up to 72 hours

Sterile swabs with cap in polyethylene, inserted in tube in polypropylene Ø 12x150mm with plastic or aluminum shaft.  
Swab available dry or with various transport media: Amies, Amies with charcoal and Stuart.



- ▶ Sterile
- ▶ Plastic or aluminium applicator
- ▶ Cotton swab
- ▶ Without medium
- ▶ Tubes in polypropylene
- ▶ Medical Device class IIA sterile

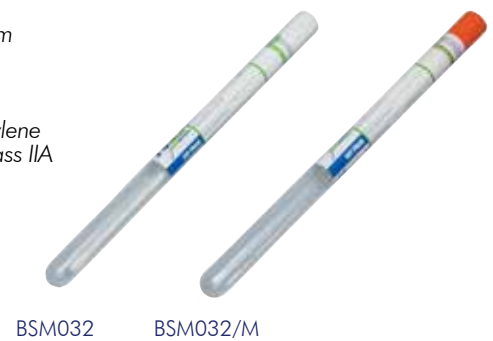

Dry swab: wooden applicator 150 mm

CAT. NO.	Sterile	Length (mm)	Internal Packaging	Sale unit
BSM031	X	150	individually wrapped in box of 500	5000
BSM030		150	bag / 2000	10000

Sterile swab with applicator. Tube Ø12x150mm in polypropylene without medium

CAT. NO.	Applicator material	Cap color	Internal Packaging	Sale unit
BSM032	Plastic	white	100	1000
BSM032/M	Aluminum	orange	100	1000

- ▶ Sterile
- ▶ Plastic or aluminium applicator
- ▶ Single packed peel pack
- ▶ Viscose swab
- ▶ Applicator aside
- ▶ With medium
- ▶ Tube in polypropylene
- ▶ Medical Device class IIA sterile

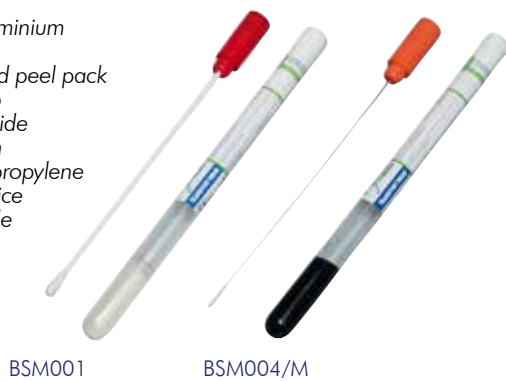

- ▶ Sterile
- ▶ Length 150 mm
- ▶ Single packed peel pack



Sterile swab with medium

CAT. NO.	Medium	Applicator material	Cap color	Internal Packaging	Sale unit
BSM001	Stuart	Plastic	red	150	900
BSM001/M	Stuart	Aluminum	red	150	900
BSM003	Amies	Plastic	blue	150	900
BSM003/M	Amies	Aluminum	blue	150	900
BSM004	Amies + Charcoal	Plastic	black	150	900
BSM004/M	Amies + Charcoal	Aluminum	black	150	900

Sterile wooden tongue depressor: single packed wrapped, sterile

CAT. NO.	Sterile	Length (mm)	Internal Packaging	Sale unit
BSM011	X	150	Single packed	100

## FOAM SWABS WITH LIQUID COLLECTION-TRANSPORT MEDIUM

### INTENDED PURPOSE

Swab Intended purpose is **"MEDICAL DEVICE" CLASS II ASTERILE**. Swabs are sterile and ready-for-use systems intended for clinical samples drawing, transport and maintenance for cultural exam. The swab is suitable for short contact with the human body including surgical wounds. Test Tubes are classified as IVD and are intended only for the preservation of samples. Product must be used as directed, Microbiotech is not responsible for any unauthorized use.

### For professional use only.

National classification of medical devices (CND - For Italian law) > **V901302** (Transport swabs for collection sample)

### APPLICATOR

**Special polyurethane foam**, medical grade, swab tip that allows a better clinical sample collection and the following immediate release into the liquid transport medium. The soft foam bud is more comfortable for patients, and has significant advantages for both conventional and molecular methods. It has a **plastic shaft with "breakpoint"** to allow the swab breaking into the test tube and the successive collection by the screw "capture" cap after the tube closing. It allows to dispose of the swab together with the cap in a safer way.

### Available in two versions on sampling site base:

**1. Standard tip:** swabs, standard dimensions, for buccal, nasal, throat, vagina, rectal, cutaneous and wound sampling; this specialty applicator is tipped with medical grade polyurethane foam. It is bonded securely to the plastic handle. The best choice for buccal swab, for general specimen collection for testing and screening. Used in Pediatrics, Ophthalmology, Veterinary care, and oropharyngeal applications.



**Overall Length:** 152.4 mm (6")

Tip Ø 4.775 mm (0.188") - Length 16.002 mm (0.63")

Handle Ø 2.54 mm (0.1") - Length 149.225 mm (5.875")

**2. Fine tip:** swabs, small dimensions, for paediatric, urethra, urogenital and nasopharyngeal sampling. The special small applicator is tipped with medical grade polyurethane foam. It is bonded securely to the plastic handle. The best choice for paediatric, urethral and nasopharyngeal applications.



**Overall Length:** 152.4 mm (6")

Tip Ø 1.981 mm (0.078") - Length 17.45 mm (0.687")

Handle Ø 2.159 mm (0.085") tapered to Ø 1.016 mm (0.040") - Length 148.539 mm (5.848")

### TEST TUBE

Liquid Transport Medium is contained in a cylindrical test tube **Ø 13x80 mm**, in transparent, unbreakable medical polypropylene (PP), to preserve sample and users safety. With screw cap in polyethylene (HDPE) with **"capture cap" technology**, The specific color cap identifies instantly and secure the medium content. Pre-labelled on test tube to allow a correct patient and sample identification. Item code, lot number and expiry date printed on each label for a full traceability.

## AMIES LIQUID TRANSPORT MEDIUM



Swabs with pink screw cap test tube containing 1 ml of liquid AMIES transport medium for the sampling and preservation of aerobes, anaerobes and other fastidious bacteria such as *Streptococcus pyogenes*, *Neisseria gonorrhoeae*, *Bacteroides fragilis*, *Haemophilus influenzae*, *Streptococcus pneumoniae*, etc within 48 hours (24 hours for *Neisseria gonorrhoeae*) at room or refrigerated temperature.

They can be used for the collection and preservation of mycobacterium and fungi.

Amies is a medium of conservation consisting of inorganic phosphate, calcium and magnesium salts and sodium chloride with a reduced environment due to the presence of sodium thioglycollato.

CAT. NO.	Description	Sale unit
BSM080	Standard tip	600 pcs (6x100 pcs)
BSM081	Fine tip	600 pcs (6x100 pcs)

## STUART LIQUID TRANSPORT MEDIUM



Swabs with blue screw cap test tube containing 1 ml of liquid STUART transport medium for the sampling and preservation of bacteria *Neisseria gonorrhoeae*, *Trichomonas vaginalis*, *Haemophilus influenzae*, *Bacteroides fragilis*, *Pseudomonas aeruginosa*, *Streptococcus pneumoniae*, *Streptococcus pyogenes*, *Corynebacterium diphtheriae*, enterobacteria and bacteria of the upper respiratory tract. These microorganisms are kept viable for no more than 24 hours. More resistant bacteria are kept for 72 hours; rule of thumb is, however, to submit to the microbiological analysis, as soon as possible, all samples.

CAT. NO.	Description	Sale unit
BSM082	Standard tip	600 pcs (6x100 pcs)
BSM083	Fine tip	600 pcs (6x100 pcs)



## CARY BLAIR LIQUID TRANSPORT MEDIUM



Swabs with green screw cap test tube containing 2 ml of liquid CARY BLAIR transport medium, for the fecal or rectal clinical samples and for preservation of enteric pathogens agents as Salmonella, Vibrio, Escherichia coli, Shigella flexneri, S. typhimurium, E. faecalis (VRE), V. parahaemolyticus, Y. enterocolitica, C. jejuni, C. difficile, Campylobacter. The Cary Blair Transport Liquid Medium is especially suitable in epidemiological investigations for Vibrio parahaemolyticus, rectal swabs, especially when they have to be transported to a central diagnostic laboratory.

CAT. NO.	Description	Sale unit
BSM084	Standard tip	600pcs (6x100pcs)
BSM085	Fine tip	600pcs (6x100pcs)

## SELENITE LIQUID MEDIUM



Swabs with white screw cap test tube containing 2 ml of liquid medium SELENITE (Selenite broth) type for the fecal clinical samples or rectal swab, designed for the transportation, survival and isolation of Salmonella enterica and Shigella sonnei, reducing the growth of the other enteric pathogens like Escherichia coli and fecal streptococci. The selenite present in the medium inhibit microorganisms other than Salmonella, particularly coliforms and enterococci. Pseudomonas and Proteus are not inhibited. Dipotassium phosphate maintains constant pH and reduces the toxicity of selenium.

CAT. NO.	Description	Sale unit
BSM086	Standard tip	600pcs (6x100pcs)
BSM087	Fine tip	600pcs (6x100pcs)

## SALINE SOLUTION



Swabs with light blue screw cap test tube containing 2 ml of sterile buffered saline sodium chloride solution, pH 7.2. Particularly suitable to obtain immediately a ready to use dilute clinical sample solution for inoculation and analysis.

CAT. NO.	Description	Sale unit
BSM088	Standard tip	600pcs (6x100pcs)
BSM089	Fine tip	600pcs (6x100pcs)

## FOAM TRANSPORT SYSTEM FOR VIRUS, CHLAMYDIA, MYCOPLASMA AND UREAPLASMA



Devices ready to use, composed by a foam swab with a plastic shaft and a test tube with screw cap containing a room temperature stable viral transport medium, suitable for the transportation and preservation of Viruses (such as Influenza H1N1), Chlamydia, Mycoplasma and Ureaplasma specimens. The Devices standard dimensions make them suitable both for use with automatic instruments whether for manual use. The liquid medium type allows to dilute the samples easily and rapidly obtaining a homogeneous solution ready to be used and appropriate in order to obtain many samples equal rates to carry out different analysis.

Foam Virus Liquid Swabs are packed in peel-pack, easy opening for the Devices optimal protection. The Devices are produced according to GMP (Good Manufacturing Practice), classified and certified as Medical Devices.

Foam Virus Liquid Swabs are sterile (SAL 10<sup>-6</sup>), Pyrogen free & Latex free.

CE MD marked sterile Swab-manufactured in compliance with 93/42/EC Directive (Italian D.lgs 46 del 24/02/1997) + 2007/47/EC CE IVD marked sterile Test Tube with medium - manufactured in compliance with 98/79/EC Directive (Italian D.lgs 332 del 08/09/2000)

CAT. NO.	Volume	Description	Sale unit
BSM090	1 ml	Standard tip	600pcs (6x100pcs)
BSM091	1 ml	Fine tip	600pcs (6x100pcs)
BSM093	3 ml	Standard tip	600pcs (6x100pcs)
BSM094	3 ml	Fine tip	600pcs (6x100pcs)



## TEST TUBES, STOPPERS, RACKS

For more details please visit:

<http://www.biosigma.com/test-tubes-stoppers-racks.html>

### STERILE POLYSTYRENE CENTRIFUGE TUBES WITH SCREW CAPS

- ▶ Sterile
- ▶ In polystyrene
- ▶ Screw cap
- ▶ Conical or cylindrical bottom

CAT. NO.	Volume (ml)	Dimensions (mm)	Bottom	Graduation	Label	Cap	Internal packaging	Sale unit
BSM483	15	Ø 17 x 120	conical	X	engraved	blue	bag / 50	case / 500
BSM470	10	Ø 16 x 100	cylindrical			red	bag / 200	case / 1200
BSM470/CS	10	Ø 16 x 100	cylindrical			red	single packed	case / 750
BSP2501	10	Ø 16 x 100	conical			white	bag / 150	case / 450



BSM483

BSM470

BSP2501

# TEST TUBES, STOPPERS, RACKS

## CLEARLine® CENTRIFUGE TUBES



CLEARLine centrifuge tubes are applicable in molecular biology as disposable laboratory consumables which are manufactured from high transparency polypropylene. Two types of volume are available to meet general need: 15 ml and 50 ml. A ring molded on inner surface of cap make an excellent seal to prevent leak of liquid. Marking area is printed in white to make tube easy for identification. Clearly graduation in black on the surface is helpful for users to calibrate. Preferably, 3 ml graduation molded on conical bottom improves the accuracy of centrifuge tube.

All CLEARLine centrifuge tubes are packaged in bags or racks with sterilization, RNase-free, DNase-free and Non-pyrogenic.

- ▶ 15ml and 50ml volume
- ▶ High transparency polypropylene
- ▶ Molded ring in the cap inner surface grants an excellent seal to prevent leak of liquid
- ▶ White writing area for easy identification
- ▶ Black graduation
- ▶ Conical and self-standing bottom
- ▶ Can be centrifuged up to 14,800 x g for 50 ml and 10,280 x g for 15 ml centrifuge tubes
- ▶ Sterilised at gamma rays SAL 10<sup>6</sup>
- ▶ RNase-free, DNase-free and Non-pyrogenic
- ▶ Autoclavable at 121 °C during 20 min.

Packaging information:

- ▶ Lot number is printed on packaging for tracking
- ▶ Heat-sealed bag, reusable zip bag
- ▶ PS rack, heat shrinking pack

**CLEARLine®**  
"Be cool, be safe, be CLEARLine"



CL482

CL474

CL477



CL475

### CLEARLine Centrifuge tube-15-50 ml

CAT. NO.	Vol. (ml)	Dimensions (mm)	Centrifugation speed	Bottom style	Raw Material	Rack	Certifications	Inner Bag	Sale unit
CL474	50	116 x 28	12000 r/min; 14800 x g	Conical	polypropylene		RNase-free DNase-free Non-pyrogenic Sterile	25	500
CL475	50	116 x 28	12000 r/min; 14800 x g	Conical		X		25	500
CL477	50	118 x 28	12000 r/min; 14800 x g	Self standing				25	500
CL482	15	120 x 16	10000 r/min; 10280 x g	Conical				25	500
CL490	15	120 x 16	10000 r/min; 10280 x g	Conical		X		50	500

## FLAT BOTTOM TEST-TUBES WITH SCREW CAPS

- ▶ Non sterile
- ▶ Screw cap
- ▶ Flat bottom

CAT. NO.	Volume (ml)	Dimensions (mm)	Bottom	Screw cap	Raw material	Cap	Internal packaging	Sale unit
BSM440	10	Ø 15 x 100	flat	X	polystyrene	white	100	2000
BSM441	5	Ø 15 x 55	flat	X	polypropylene	blue	100	2000



BSM440



BSM441

## STERILE POLYSTYRENE TEST-TUBES WITH PRESSURE CAPS

- ▶ Sterile
- ▶ In polystyrene
- ▶ Pressure yellow or red cap
- ▶ Cylindrical or conical bottom
- ▶ Graduated

CAT. NO.	Volume (ml)	Dimensions (mm)	Bottom	Graduation	Label	Cap	Sterile	Sale unit
BSM416	5	Ø 12 x 86	cylindrical	2.5 / 5 ml	X	yellow	X	case / 3000
BSM400	10	Ø 16 x 100	cylindrical	2.5 / 5 / 10 ml		yellow	X	case / 1800
BSM402	10	Ø 16 x 100	cylindrical	2.5 / 5 / 10 ml	X	red	X	case / 1250
BSM408	10	Ø 16 x 100	conical	1/2,5/5/10 ml		yellow	X	case / 2000
BSM410	10	Ø 16 x 100	conical	1/2,5/5/10 ml	X	red	X	case / 800



BSM416



BSM400

# TEST TUBES, STOPPERS, RACKS

## VACUUM TUBES FOR URINE ANALYSIS

- ▶ Sterile
- ▶ In rack of 100 pcs
- ▶ Labelled
- ▶ Yellow cap



Cylindrical urine test-tube with yellow cap, in rack

CAT. NO.	Description	Dimensions (mm)	Label	Boric Acid	Int. Pack	Ext. Pack
BV057	for 4 ml of urine	13 x 75	X		100	1200
BV058	for 6 ml of urine	13 x 100	X		100	1200
BV059	for 10 ml of urine	16 x 100	X		100	1200
BV060	for 10 ml of urine	16 x 100	X	X	100	1200

## VACUUM URINE CONTAINERS

Vacuum urine container 120 ml in polypropylene with screw cap, with frosted side

- ▶ Sterile or not sterile
- ▶ Container in polypropylene
- ▶ Cap in polyethylene



Vacuum urine container

CAT. NO.	Volume (ml)	Sterile	Raw Material	Internal packaging	Sale unit
BSC200	120	X	PP	Single packed	case / 250
BSC201	120		PP	Single packed	case / 250
BSC202	120		PP	in bulk	case / 300

## SERUM SEPARATOR TUBES IN RACK



Tubes housed in a rack of 50 pcs. Speed of rotation in centrifuge 3,500 (rpm).

- ▶ With separator granular and coagulation accelerator
- ▶ In rack of 50 pcs
- ▶ White stopper
- ▶ Centrifugal speed 3,500 (rpm)



Blood collecting tube with granular separator and coagulation accelerator

CAT. NO.	Volume (ml)	Dimensions (mm)	Bottom	Raw material	Stopper	Rack	Sale unit
BSTA18	10	Ø 16 x 100	cylindrical	polypropylene	white	X	case / 1000
BSTA21	10	Ø 16 x 100	cylindrical	methacrylate	white	X	case / 1000
BSTA23	5	Ø 12 x 86	cylindrical	methacrylate	white	X	case / 1000
BSTA33	4	Ø 13 x 75	cylindrical	methacrylate	white	X	case / 1000



## TEST TUBES WITH TWO-POSITION CLOSURE CAP

In polystyrene, graduated (or non) and sterile. The particularly shaped two-position cap allows, with a light touch, a good aeration of the contents and, with a stronger pressure, to obtain a leakproof closure.

CAT. NO.	Volume (ml)	Dimensions (mm)	Bottom	Grad.	Label	Cap	Internal packaging	Sale unit
BSF2054/K	6	Ø 12 x 75	cylindrical			X	bag / 250	case / 1000
BSF2054/CS	5	Ø 12 x 75	cylindrical	X	engraved	X	individually wrapped	case / 500
BSF2051	14	Ø 17 x 100	cylindrical	X	engraved	X	bag / 50	case / 500
BSF2051/CS	14	Ø 17 x 100	cylindrical	X	engraved	X	individually wrapped	case / 500



## NON STERILE TEST-TUBES



### 3 ml volume tube

CAT. NO.	Dimensions (mm)	Bottom	Raw material	Rim	Graduation (ml)	Note	Label	Internal packaging	Sale unit
BSA060	Ø 11 x 70	cylindrical	polystyrene			for R.I.A.		bag / 1000	case / 6000
BSP068	Ø 12 x 51	flat	polypropylene	X	1.25 / 25 / 2.5			bag / 1000	case / 5000
BSP069	Ø 12 x 51	flat	polypropylene	X	1.25 / 25 / 2.5		X	in bulk	case / 7000
BSP082	Ø 12 x 51	flat	polystyrene	X	1.25 / 25 / 2.5			in bulk	case / 7000
BSP083	Ø 12 x 51	flat	polystyrene	X	1.25 / 25 / 2.5		X	in bulk	case / 7000
BSP066	Ø 12 x 56	cylindrical	polypropylene	X	0.5 / 1 / 2 / 3			in bulk	case / 7000



BSA060



BSP068



BSP082



BSP066

### 5 ml volume tube

CAT. NO.	Dimensions (mm)	Bottom	Raw material	Rim	Graduation (ml)	Color	Label	Internal packaging	Sale unit
BSA059V	Ø 12x75	cylindrical	polystyrene			neutral		bag / 1000	case / 4000
BSA059V/P	Ø 12x75	cylindrical	polypropylene			neutral		bag / 1000	case / 4000
BSA0592	Ø 12x75	cylindrical	polystyrene			blue		bag / 1000	case / 4000
BSP056	Ø 12 x 86	cylindrical	methacrylate	X	2.5 / 5	neutral		bag / 1000	case / 5000
BSP062	Ø 12 x 86	cylindrical	polypropylene	X	2.5 / 5	neutral		in bulk	case / 4000
BSP063	Ø 12 x 92	cylindrical	polypropylene	X	2.5 / 5	neutral	X	in bulk	case / 3600
BSP076	Ø 12 x 86	cylindrical	polystyrene	X	2.5 / 5	neutral		in bulk	case / 4000
BSP077	Ø 12 x 92	cylindrical	polystyrene	X	2.5 / 5	neutral	X	in bulk	case / 3600



BSA059V



BSA059V/P



BSP062



BSP056

### Rimless test-tube 13x75mm

CAT. NO.	Volume (ml)	Dimensions (mm)	Bottom	Raw material	Color	Internal packaging	Sale unit
BSA0594	6	Ø 13x75	cylindrical	polystyrene	neutral	bag / 1000	case / 4000
BSA0594/P	6	Ø 13x75	cylindrical	polypropylene	neutral	bag / 1000	case / 4000



BSA0594



BSA0594/P

### 10 ml volume tube

CAT. NO.	Dimensions (mm)	Bottom	Raw material	Rim	Graduation (ml)	Label	Internal packaging	Sale unit
BSP054	Ø 16 x100	cylindrical	methacrylate	X			in bulk	case / 2000
BSP055	Ø 16 x100	cylindrical	methacrylate	X		X	in bulk	case / 2000
BSP048	Ø 16 x100	cylindrical	polypropylene	X			in bulk	case / 2000
BSP049	Ø 16 x100	cylindrical	polypropylene	X		X	in bulk	case / 2000
BSP058	Ø 16 x100	cylindrical	polypropylene	X	2.5 / 5 / 10		in bulk	case / 2000
BSP059	Ø 16 x100	cylindrical	polypropylene	X	2.5 / 5 / 10	X	in bulk	case / 2000
BSP072	Ø 16 x100	cylindrical	polystyrene	X	2.5 / 5 / 10		in bulk	case / 2000
BSP073	Ø 16 x100	cylindrical	polystyrene	X	2.5 / 5 / 10	X	in bulk	case / 2000
BSP060	Ø 16 x103	conical	polypropylene	X	0.5 / 1 / 2.5 / 5 / 10		in bulk	case / 2000
BSP061	Ø 16 x103	conical	polypropylene	X	0.5 / 1 / 2.5 / 5 / 10	X	in bulk	case / 2000
BSP074	Ø 16 x103	conical	polystyrene	X	0.5 / 1 / 2.5 / 5 / 10		in bulk	case / 2000
BSP075	Ø 16 x103	conical	polystyrene	X	0.5 / 1 / 2.5 / 5 / 10	X	in bulk	case / 2000



BSP048



BSP058



BSP060



BSP072



BSP074

# TEST TUBES, STOPPERS, RACKS

## DROSOPHILA

- ▶ Vials for drosophila
- ▶ In carton-rack of 100 pcs or bulk
- ▶ In polystyrene
- ▶ 2 formats of tubes: 25 x 95 or 28.5 x 95 mm

CAT. NO.	Dimensions (mm)	Bottom	Raw material	Case	Internal packaging	Sale unit
789001B	Ø 25 x 95	self standing	polystyrene	Rack	100	500
789002	Ø 28.5 x 95	self standing	polystyrene	Rack	100	500
789008	Ø 25 x 95	self standing	polystyrene	Bulk	-	500
789009	Ø 28.5 x 95	self standing	polystyrene	Bulk	-	500



You can find all Drosophila accessories on Dutscher's catalogue, chapter "Tubes and Rack"

## CAPS



### Polyethylene stoppers with wings

- ▶ For Ø12 or Ø16 mm tubes
- ▶ With wings
- ▶ In polyethylene
- ▶ 8 colors available



Color	Ø 12 mm CAT. NO.	Ø 16 mm CAT. NO.
neutral	BSA062	BSA063
light blue	BSA062/AZ	BSA063/AZ
white	BSA062/B	BSA063/B
blue	BSA062/BLU	BSA063/BLU
yellow	BSA062/G	BSA063/G
pink	BSA062/RA	BSA063/RA
red	BSA062/RO	BSA063/RO
green	BSA062/V	BSA063/V
<b>Internal Packaging</b>	bag / 1000	bag / 1000
<b>Sale unit</b>	case / 20000	case / 10000

### Security stoppers for tubes

- ▶ For Ø12 mm tubes
- ▶ Safety closure
- ▶ In polyethylene
- ▶ 5 colors available



Color	CAT. NO.	Tubes	Internal packaging	Sale unit
white	BSO100	BSA059V BSA059V/P BSA0592	bag / 1000	case / 12000
blue	BSO100/BLU		bag / 1000	case / 12000
green	BSO100/V		bag / 1000	case / 12000
grey	BSO100/GR		bag / 1000	case / 12000
red	BSO100/RO		bag / 1000	case / 12000

### Polyethylene stoppers

- ▶ For Ø12 or Ø16 mm tubes
- ▶ In polyethylene
- ▶ 7 colors available



Color	Ø 12 mm CAT. NO.	Ø 16 mm CAT. NO.
red	BSO036	BSO025
white	BSO037	BSO026
yellow	BSO038	BSO027
dark green	BSO039	BSO028
light blue	BSO040	BSO029
blue	BSO041	BSO030
pink	BSO043	BSO032
<b>Sale unit</b>	case / 4000	case / 10000

### White R.I.A. stoppers

White R.I.A. stopper in polyethylene, Ø 11 mm for BSA060.



CAT. NO.	Diameter (mm)	Raw material	Internal packaging	Sale unit
BSA061	Ø 11	polyethylene	bag / 1000	case / 3000

### Vacustopper™



- ▶ In polyethylene Ø 13 mm
- ▶ For vacuum tubes reclosing or for sorwall test-tubes Ø 12 and 13 mm
- ▶ internal shape to allow the cap to join the tube internally
- ▶ Suitable with vacuum tubes: BD Vacutainer®, Venosafe®, Vacuette® Greiner-Bio One®

CAT. NO.	Diameter (mm)	Raw material	Internal packaging	Sale unit
BSO113	Ø 13	polyethylene	bag / 1000	case / 4000

# TEST TUBES, STOPPERS, RACKS

## CRYOGENIC STORAGE BOXES FOR VACUUM TUBES

- ▶ To meet the demand of lab safety and ISO 15189 standard, We now launch the cryogenic storage box for vacuum tubes after analyzed, It makes the work for blood specimen after treatment faster, easier, and safer. It's the ideal choice for laboratory safety and quality control
- ▶ According to different sealing method, it can be divided into three types: Silicagel pad, Sticky foam pad and no pad with the tube cap on
- ▶ For different clinical department, Testing items and date, We prepared 6 different colors for each of the three kinds of box: Red, Orange, Yellow, Green, Blue and Purple
- ▶ According to the tube size, each of the three types can match with tubes of two specifications: Ø13x75mm and Ø13x100mm
- ▶ To avoid any inconvenience caused by unnormal label (like multi-layer label, turnup label or corrugated label) or non-standard bigger diameter tube

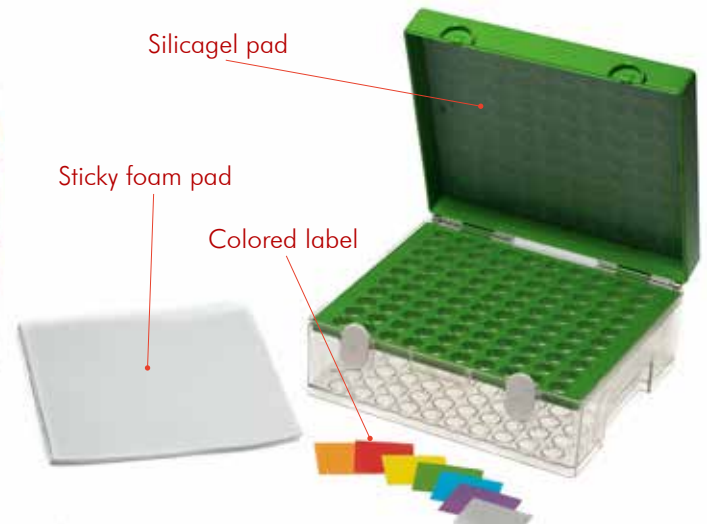
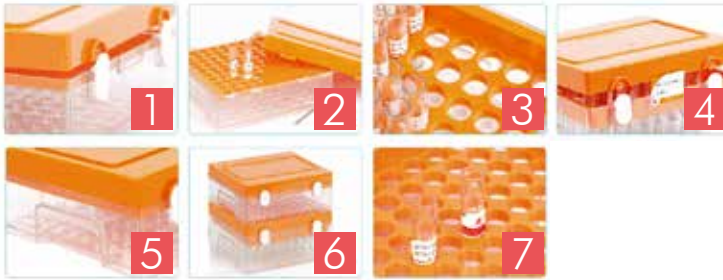

1. Press down the cover slightly, the box will automatically lock and seal, one light press on the
2. Detachable design allows it to be used as a test tube rack.
3. Moulded code no of 1-100, convenient for locating the samples.
4. Multi-color label, Easy to write related information and put on the box.
5. Hidden handle design, brief and delicate.
6. Particular locating slot design makes boxes stack available without moving or sliding.
7. Convenient to put or take out tubes with unnormal label (like multi-layer label, turnup label or corrugated label), or tubes with big diameter less than Ø14mm).

CAT. NO.	Description	Sale unit
BSP278	CryoGenic storage box for 13x75 mm Vacuum Tubes, 100 places, sticky foam pad, 6 colours available	6
BSP277	CryoGenic storage box for 13x100 mm Vacuum Tubes, 100 places, sticky foam pad, 6 colours available	6

## RACKS

### 50 places racks

Abs stackable rack with alphanumerical grid

- ▶ In ABS
- ▶ Stackable
- ▶ With alphanumerical grid
- ▶ White
- ▶ 50 Places



### Racks for haemolysis tubes

- ▶ Made of polypropylene
- ▶ For tubes of ø 13, 16, 20, 25 and 30 mm
- ▶ Supplied flat
- ▶ Stackable
- ▶ Marking area on the two lengths
- ▶ Autoclavable
- ▶ Alphanumeric referencing on the tray
- ▶ 4 colours available: white, blue, yellow, red



CAT. NO.	Places	Ø (mm)	dim. (mm)	h (mm)	Color	Sale unit
BSP213	50	13.0	210 x 102	50	White	12
BSP217	50	16.0	240 x 110	53	White	12

For Tubes Ø	Tubes number	L x l x h (mm)	white	blue	yellow	red
13 mm	90 (6 x 15)	246 x 105 x 64	391074	391075	391076	391077
16 mm	60 (5 x 12)	246 x 105 x 72	391078	391079	391080	391081
20 mm	40 (4 x 10)	246 x 105 x 72	391082	391083	391084	391085
25 mm	40 (4 x 10)	295 x 125 x 85	391086	391087	391088	391089
30 mm	24 (3 x 8)	300 x 112 x 85	391090	391091	391092	391093
Sale unit			1	1	1	1

# TEST TUBES, STOPPERS, RACKS

## Box for tubes 15, 20, 30 and 50 mL with lid

Rigid boxes composed of a coloured support fixed onto a translucent bottom and a translucent covering lid for complete observation of the tubes.

- ▶ For tubes of 15, 20, 30 and 50 mL
- ▶ Can be used from -5 °C to +125 °C
- ▶ With numbering index



CAT. NO.	L x d x h (mm)	Tube Ø (mm)	Volume (mL)	Number of holes	Colours	Sale unit
064201	148 x 148 x 129	17	15	36	green	2
064202	148 x 148 x 60	30	20	16	mauve	2
064203	148 x 148 x 91	30	30	16	orange	2
064204	148 x 148 x 129	30	50	16	pink	2

## Rack for 15 mL and 50 mL tubes

- ▶ For 25 tubes of 50 mL or 50 tubes of 15 mL
- ▶ Autoclavable at 121 °C
- ▶ Can be frozen at -80 °C
- ▶ Stackable
- ▶ Snap-on



Tubes (ml)	Natural	White	Yellow	Orange	Red
15	949000	949001	949002	949003	949004
50	949009	949010	949011	949012	949013
Sale unit	5				

Tubes (ml)	Violet	Blue	Green	Assorted
15	949005	949006	949007	949008
50	949014	949015	949016	949017
Sale unit	5			

## Racks for 15 and 50 mL tubes

- ▶ In polypropylene
- ▶ Autoclavable at +121 °C
- ▶ Temperature range -80 °C



CAT. NO.	Description	dim. (mm)	Sale unit
049730	Blue rack for 18 tubes of 15 ml	122 x 88 x 70	1
049731	Blue rack for 6 tubes of 50 ml	122 x 88 x 70	1
049732	Blue rack for 12 tubes of 50 ml	234 x 88 x 70	1

## 5ml / 15 mL tube rack

- ▶ 2 moving hinged upper shelves able to hold 5 mL or 15 mL tubes (up to 16 mm in diameter)
- ▶ Tear drop shaped openings for a better retention of tubes
- ▶ Imprinted grid of both sides of the upper shelves
- ▶ Dimensions : 30,9 x 10,7 x 7,7 cm
- ▶ Autoclavable at 121 °C for 15 min.



CAT.NO	Description	Color	Sale unit
320532	5ml / 15 mL tube rack, 40 wells	purple white	1
320533	5ml / 15 mL tube rack, 40 wells	green blue	1

## Acetal multi-racks

- ▶ 3 models for tubes of 13, 16 or 30 mm
- ▶ Made from a highly resistant acetal based polymer
- ▶ Autoclavable from 20 °C to 120 °C
- ▶ L x w x h: 293 x 115 x 65 mm



Ø (mm)	Tubes Capacity	Blue	Green	Maive	Orange	Yellow
13	84	039837	039838	039839	039840	039841
16	60	039842	039843	039844	039845	039846
30	18	039847	039848	039849	039850	039851
Sale Unit		1				



# TEST TUBES, STOPPERS, RACKS

## Reversible multi-sided racks

A large choice of configurations. The reversible racks can be used to store all diameters of tubes, microtubes, cryotubes. The choice of multiple colours enables preparations to be organised and tubes to be identified on the lab bench. Made from autoclavable polypropylene, they can tolerate water-baths and freezing.

### 4 possible configurations:

#### Configuration A: 4 sides for:

- ▶ 32 microtubes 0.5 mL
- ▶ 32 microtubes 1.5 mL or tubes  $\varnothing$  12 mm
- ▶ 12 conical tubes 15 mL  $\varnothing$  17 mm
- ▶ 4 conical tubes 50 mL  $\varnothing$  30 mm
- ▶ L x w x h: 89 x 50 x 17 mm.

#### Configuration B: 4 sides for:

- ▶ 8 conical tubes 50 mL  $\varnothing$  30 mm
- ▶ 20 tubes  $\varnothing$  20 mm
- ▶ 24 conical tubes 15 mL  $\varnothing$  17 mm
- ▶ 40 tubes  $\varnothing$  13 mm
- ▶ L x w x h: 195 x 100 x 100 mm.

#### Configuration C: 4 sides for:

- ▶ 12 tubes  $\varnothing$  25 mm
- ▶ 20 tubes  $\varnothing$  20 mm
- ▶ 24 conical tubes 50 mL  $\varnothing$  17 mm
- ▶ 40 tubes  $\varnothing$  13 mm
- ▶ L x w x h: 195 x 100 x 100 mm.

#### Configuration D: 4 sides for:

- ▶ 4 conical tubes 50 mL  $\varnothing$  30 mm
- ▶ 10 conical tubes 15 mL  $\varnothing$  17 mm
- ▶ 12 tubes  $\varnothing$  12 mm
- ▶ 16 microtubes 1.5 mL or 2 mL
- ▶ L x w x h: 195 x 100 x 100 mm.

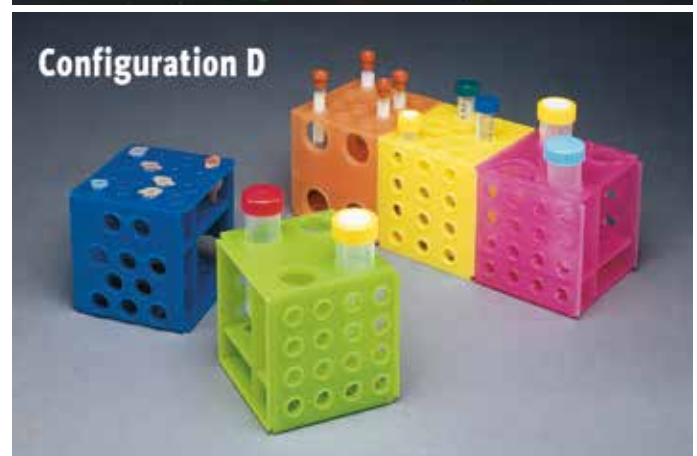

Color	Configuration A	Configuration B	Configuration C	Configuration D
natural	037559	045430	-	-
blue	037560	045431	045439	-
green	037561	045432	045440	-
orange	037562	045433	045441	-
pink	037563	045434	045442*	-
yellow	037564	045436	-	-
violet	-	-	045438	-
mix 5 color	037565	045437	045443	037572

\*red

## Barrel rack

Rack with pivoting modules like a barrel. Can be used as simple module or snapped on. Block of four racks in green, blue, red and yellow colours.

- ▶ Dimensions: 108 x 108 x 69 mm
- ▶ Made from polypropylene
- ▶ Autoclavable with caution
- ▶ Temperature range -80 °C to +121 °C
- ▶ Capacity: 2 tubes 50 mL, 8 tubes 15 mL, 12 microtubes 1.5 mL or 2 mL maximum diameter 11 mm, 6 microtubes 0.5 mL maximum diameter 8 mm, one PCR plate using two modules, 6 strips of 8 PCR microtubes per module, 8 strips of 12 PCR tubes on 2 modules, 48 PCR microtubes on 1 module



CAT. NO.	Description	Sale unit
048021	Barrel rack	1
048021B	ECO rotator workstation	1



## E.S.R. SYSTEM

*For more details please visit:*

*<http://www.biosigma.com/e-s-r-system.html>*

The Erythrocyte Sedimentation Rate (ESR) is a non-specific test that alerts physicians to the possible presence of body diseases or abnormalities. The ESR is determined by measuring, in millimeters per hour, the distance red cells have fallen after separating from the plasma in a vertical sed-rate pipette. The manual test takes 60 minutes to completed.

## E.S.R. PIPETTES

### E.S.R. glass pipette



The glass pipette can be used to withdraw blood from any kind of test-tube. Direct suction system to allow the lab-technician, by pulling the internal piston upwards, to let the blood column reach the "0" level, with automatic stop. The pipette is graduated from "0" to "180", with a transparent background for immediate reading. The rack can hold ten pipettes in pre-numbered position and ensures every pipette a perfectly vertical position.

- ▶ Transparent glass tube
- ▶ Graduation 0-180 ml
- ▶ With a polyethylene piston



CAT. NO.	Description	Dimensions (mm)	Graduation (mm)	Scale distance (mm)	Internal pack	Sale unit
BSV012	E.S.R. glass pipette, graduated, with a polyethylene piston	L 210, Ø 4.45	0 - 180	10	case / 500	case / 2000

### E.S.R. plastic pipettes

The polystyrene pipette is graduated from 0 to 170mm and features a unique fibrous plug located at the zero mark. The plug is specifically designed to be a self-sealing aerosol barrier that stops hazardous substances from escaping through the top of the pipette.

- ▶ Graduation 0-170 ml
- ▶ With fibrous plug
- ▶ With closure system

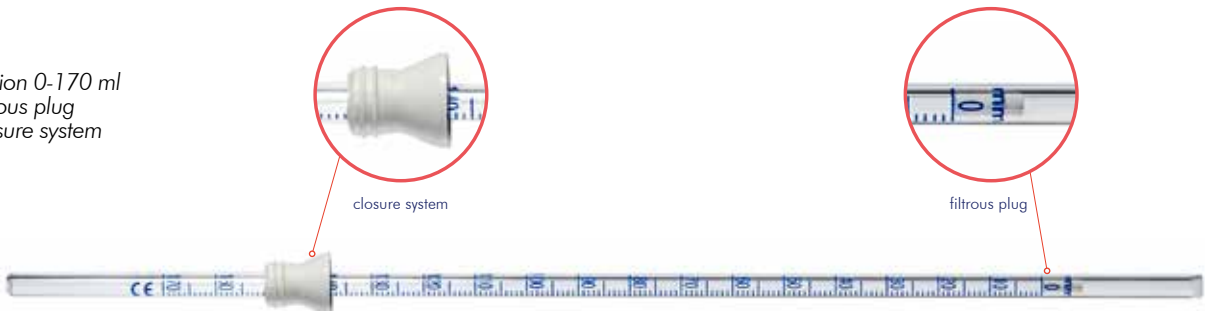

CAT. NO.	Description	Dimensions (mm)	Graduation (mm)	Internal pack	Sale unit
BSV0123P	E.S.R. plastic pipette graduated with an aspirator	L 230, Ø 4.45	0 - 170	case / 200	case / 800

## E.S.R. TUBES

NA Citrate test tube ideal for E.S.R. System



CAT. NO.	Description	Sale unit
BSV0121	NA Citrate Tube 0.106 ml/ESR, 12x55 mm with a black pierceable cap, in polypropylene	1000
BST128	E.S.R. TUBE with 0,25 ml NA Citrate, for 1 ml of blood, Ø 12 x 56 mm, pink stopper, labelled, with no pierceable stopper, in polypropylene. Double arrow indicative at 1 ml and 2.25 ml.	1500

## E.S.R. RACKS

10-PLACE RACK WITH PIPETTE SUPPORT CLAMPS

This unique rack features support clamps that hold the pipettes in a perfectly vertical position.

- ▶ In ABS
- ▶ 10 places
- ▶ White color
- ▶ With support camps



Rack

CAT. NO.	Description	Raw material	Internal packaging	Sale unit
BSV011	10-place E.S.R. rack in ABS	ABS	1	5



## RAPID TESTS

*For more details please visit:*

*<http://www.biosigma.com/rapid-tests.html>*

# RAPID TESTS

## FECAL OCCULT BLOOD TEST

A rapid, one step test for the qualitative detection of Human Occult Blood in feces.

- ▶ Rapid chromatographic immunoassay for the qualitative detection of Human Occult Blood in feces
- ▶ For professional in vitro diagnostic use only
- ▶ CE marked



Fecal occult blood device

CAT. NO.	Description	Sample	Sensitivity	Sale unit
BSD680	Test in card + Bottle with buffer solution for dilution of stool sample.	feces	50 ng/ml	25

## PREGNANCY RAPID TESTS

The hCG One Step Pregnancy Test Device (Urine/Serum) is a rapid chromatographic immunoassay for the qualitative detection of human chorionic gonadotropin in urine or serum to aid in the early detection of pregnancy.

The hCG One Step Pregnancy Test Device (Urine/Serum) is a preliminary qualitative test, therefore, neither the quantitative value nor the rate of increase in hCG can be determined by this test.

The test contains anti-hCG particles and anti-hCG coated on the membrane.

*For professional in vitro diagnostic use only.*



CAT. NO.	Description	Sample	Sensitivity	Sale unit	CAT. NO.	Description	Sample	Sensitivity	Sale unit
BSD525	Fast-Step hCG in card	Serum-Urine	25 mIU/ml	40	BSD5250	Fast-Step hCG in strip	Serum-Urine	25 mIU/ml	50

## ONE STEP DRUG SCREEN TEST DEVICE (URINE)

A rapid, one step screening test for the simultaneous, qualitative detection of drugs and drug metabolites in human urine or saliva. Tests for drugs of abuse range from simple immunoassay tests to complex analytical procedures. The speed and sensitivity of immunoassays have made them the most widely accepted method to screen urine or saliva for drugs of abuse. The One Step Drug Screen Test Device is a lateral flow chromatographic immunoassay for the qualitative detection of drugs and drug metabolites in urine or saliva.

*For medical and other professional in vitro diagnostic use only.*



### Single parameter test

#### Urine

CAT. NO.	Drug		Cut-off ng/ml	Sale unit
BSD700	MOP	Morphine	300	40
BSD701	THC	Marijuana	50	40
BSD702	COC	Cocaine	300	40
BSD703	AMP	Amphetamine	300	40
BSD704	MET	Methamphetamine	500	40
BSD706	BAR	Barbiturates	300	40
BSD707	BZO	Benzodiazepine	300	40
BSD708	MTD	Methadones	300	40
BSD709	MDMA	Methylenedioxymethamfetamin	500	40
BSD730	BUP	Buprenorphine	10	40
BSD7101	KET	Ketamine	1000	40
BSD930	CAF	Caffeine	1000	50
BSD932	LSD	LySergic Acid Diethylamide	20	40
BSD934	CAT	Cathine	150	40
BSD935	COT	Cotinine	200	50
BSD936	ETG	EthylGlucuronide	1000	40



# RAPID TESTS

## Multi-drug test



BSD711/BSD714/BSD716

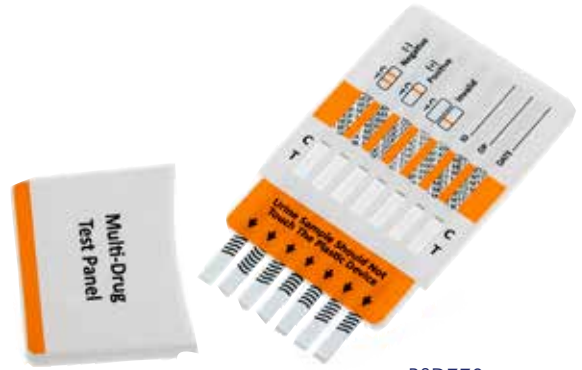

BSD770

### Urine

CAT. NO.	Parameter number	Drug	Cut-off ng/ml	Sale unit
BSD711	5	AMP COC THC MET MOP	1000 300 50 1000 300	25
BSD714	10	AMP COC THC BZO TCA BAR MET MOP MTD MDMA	1000 300 50 300 1000 300 1000 300 300 500	25
BSD716	12	AMP COC THC MET OPI PCP BZO TCA BAR MDMA MTD MOP	1000 300 50 1000 2000 25 300 1000 300 500 300 300 300	25

### Urine immersion

CAT. NO.	Parameter number	Drug	Cut-off ng/ml	Sale unit
BSD770	7	AMP COC THC MET MTD MDMA MOP	500 300 50 500 300 500 300	25
BSD778	8	MTD MDMA COC AMP MET THC MOP BUP	300 500 300 500 500 50 300 10	25



Negative

Positive

Invalid

# RAPID TESTS

## INFECTIOUS DISEASES

Immunochromatographic rapid test for the detection of infectious diseases.

All reagents and materials coming in contact with potential infectious specimens must be treated with appropriate disinfectants or autoclaved at 121°C for at least one hour.

*These tests are designed for in vitro diagnostic use only.*



### Virus

CAT. NO.	Infectious agent	Sample	Features	Sale unit
BSD585	DUO ROTA-ADENOVIRUS	Feaces	for the qualitative feaces detection of DUO ROTA- ADENOVIRUS antigen	20
BSD586	ADENOVIRUS	Feaces	for the qualitative feaces detection of ADENOVIRUS antigen	20
BSD587	ROTAVIRUS	Feaces	for the qualitative feaces detection of ROTA-ADENOVIRUS antigen	20
BSD613	MONONUCLEOSIS	Serum, Plasma, whole blood	Immunochromatographic rapid test for the detection of infectious Mononucleosis antibodies	20

### Bacteria

CAT. NO.	Infectious agent	Sample	Features	Sale unit
BSD594	TUBERCULOSIS	Serum, Plasma, whole blood	for the detection of human antibodies (IgA, IgG, IgM) to Koch's bacillus	20
BSD598	A+B CLOSTRIDIUM	Feaces	for the qualitative feaces detection of toxin A and B of Clostridium Difficile, due to antibody polyclonal binding antitoxin A and B.	20
BSD599	TETANUS	Serum, Plasma, whole blood	for qualitative detection of tetanus antitoxin antibodies. The assay is intended for helping anti- tetanus prophylaxis for patients at risk of tetanus	20
BSD600	CHLAMIDIA	Female: cervical swab Male: Urethral swab, urine	for the detection of CHLAMIDIA trachomatis	20
BSD632	H-PYLORI	Feaces	for the qualitative feaces detection of H-PYLORI	20
BSD712	SYPHILIS	Serum, Plasma	for the detection of antibodies (IgG and IgM) to Treponema pallidum (SYPHILIS)	40
BSD715	STREPTOCOCCUS A	Pharyngeal swab	for the qualitative detection of Strep A antigen. Kit with positive and negative controls	20

## CALPROTECTIN

- ▶ For professional in vitro diagnostic use only
- ▶ CE marked

### CALPROTECTIN

CAT. NO.	Description	Sample	Sale unit
BSD920	Rapid test for the determination of fecal calprotectin	feaces	10



BSD920



# RAPID TESTS

## PARASSITOLOGY

Biorepair system, parassitfecal. Biorepair system. Enrichment System for parassitology, with new reagent without formalin.

Kit includes:

- ▶ Empty Biotube with filter
- ▶ Biotube 3ml with reagent A : Baileger-solution (Xi- irritant); 0.4 %; acetic acid; Sodium acetate 15 g/l, 0.05 % sodium azide; cap with spoon
- ▶ Reagent B 100ml (Ethyl Acetate)
- ▶ Reagent C 15ml (Lugol)



### Biorepair

CAT. NO.	Description	Sample	Sale unit
BSD855/E	Biorepair, system parassit fecal	Feaces	50

## URINE ANALYSIS

Strips are made for urinalysis of both qualitative and semi-quantitative, which are in vitro reagent for diagnostics. It tests Leukocytes, Nitrite, Urobilinogen, Protein, pH, Blood, Specific Gravity, Ketone (acetoacetic acid), Bilirubin, and Glucose in urine. Please refer to the out-side box carton and bottle label for the specific test parameters of the product you are using.

The results on the strips can be read visually and instrumentally.  
*The strips are for professional use only.*

### Urinalysis strip 10 parameters

CAT. NO.	Parameter	Sale unit
BSD749SG	LEUC	Leukocytes
	NIT	Nitrites
	UR	Urobilinogen
	PR	Proteins
	PH	PH
	BLOOD	BLOOD
	SG	Specific Gravity
	KET	Ketones
	BIL	Bilirium
	BLU	Glucose
		100



## CONSUMABLES

### Plastic cassette for rapid tests

CAT. NO.	Description	Sale unit
BSD335	for 3.9 mm strips free writing	2000
BSD330	for 3.9 mm strips with HCG writing	4000
BSD310	for 5 mm strips free writing	3000
BSD300	for 5 mm strips with HCG writing	6000



### Pipette pasteur for card test

CAT. NO.	Description	Sale unit
BSV150	Pipette pasteur for card test-kit 40 µl	10000

BSD310

BSD335

BSV150



## CONTAINERS

For more details please visit:  
<http://www.biosigma.com/containers.html>

A wide range of containers for different uses such as urine, feaces, sputum collector and waste containers.

Made of high quality raw materials and with accurate graduation.

# CONTAINERS

## URINE CONTAINERS WITH SCREW CAPS

Different styles of urine containers suitable for specimen collection and test requests.  
High tightness prevents any leakage and contamination during storage and transportation.

- ▶ In clear Polypropylene or Polystyrene
- ▶ Red or white cap
- ▶ Available sterile and single packed
- ▶ Frosted writing side or with label
- ▶ Clear graduation



BSC124/123



BSC660



BSC665



BSC253



BSC258



BSC195

CAT. NO.	Colour Cap	Volume (ml)	Diameter (ml)	Heigh (mm)	Sterile	Label	Frosted Side	Raw material	Internal packaging	Sale unit
BSC124	red	30	28.0	82.0			X	PP	in bulk	case / 700
BSC123	red	30	28.0	82.0	X		X	PP	single packed	case / 500
BSC660	white	60	37.5	65.0			X	PP	in bulk	case / 600
BSC665	red	60	37.5	65.0	X		X	PP	single packed	case / 500
BSC253	white	120	56.0	70.0			X	PP	in bulk	case / 300
BSC258	red	120	56.0	70.0	X		X	PP	single packed	case / 250
BSC195	red	200	59.0	85.0	X	X		PS	single packed	case / 150
BSC198	blue	200	64.0	90.0			X	PP	in bulk	case / 600
BSC199	red	200	64.0	90.0	X		X	PP	single packed	case / 200

## FEACES CONTAINERS



BSC128



BSC132



BSC160



BSC163

- ▶ Feaces container
- ▶ In clear polypropylene or polystyrene
- ▶ With screw cap or pressure cap
- ▶ With frosted writing area or with label
- ▶ Available sterile single packed
- ▶ With spoon or paddle

CAT. NO.	Colour Cap	Volume (ml)	Caps	Spoon	Diameter (ml)	Heigh	Sterile	Graduated	Frosted Side	Raw material	Internal packaging	Sale unit
BSC128	red	30	screw	with paddle	28.0	82.5		X	X	PP	in bulk	case / 700
BSC132	red	30	screw	with paddle	28.0	82.5	X	X	X	PP	single packed	case / 500
BSC160	blue	18	pressure	with spoon	19.5	80.5				PS	bag / 250	case / 1500
BSC163	red	18	pressure	with spoon	19.5	80.5	X		Label	PS	bag / 250	case / 1000

## SPECIMEN CONTAINERS



BSC105



BSC146



BSC148

- ▶ Specimen container
- ▶ Manufactured in cristal polystyrene with high trasparency
- ▶ With polyethylene pressure cap
- ▶ Available also sterile and single packed
- ▶ Wide mouth for an easy use

CAT. NO.	Colour Cap	Volume (ml)	Caps	Spoon	Diameter (ml)	Heigh (mm)	Sterile	Raw material	Internal packaging	Sale unit
BSC105	white	30	pressure (aside)	-	33.5	39.5		PS	in bulk	case / 800
BSC146	blue	60	pressure (aside)	-	56.5	37.5		PS	in bulk	case / 400
BSC148	red	60	pressure	-	56.5	37.5	X	PS	bag / 100	case / 400

# CONTAINERS

## SURGICAL PART CONTAINERS

Shockproof polystyrene containers for surgical parts, with pressure closure.

CAT.NO.	Dimensions (mm Ø)	Volume (ml)	Printing	Sale unit
BSC2512	125 x 70	500	X	180
BSC2511	125 x 70	500		180
BSC2522	125 x 120	1000	X	180
BSC2521	125 x 120	1000		180
BSC2520	200 x 130	2500	X	52
BSC2524	200 x 130	2500		52
BSC2527	200 x 215	5000	X	40
BSC2525	200 x 215	5000		40



## 24-HOUR CONTAINERS

Tank for 24H urine collection with screw cap and plug for easy sampling. Graduated from 200 to 2500 ml with increments of 100 ml

- ▶ In polyethylene
- ▶ Graduated
- ▶ With handle
- ▶ 2500 ml

Also available amber version



CAT. NO.	Model	Vol. (ml)	Grad.	Handle	Dimensions (mm)	Sale unit
BSL483	Bottle	2500	X	X	Ø 130 x 250	case / 30
BSL486	Tank Rectangular	2500	X	ergonomic	245 x 110 x 160	case / 30

Square container for 24H urine collection. With screw cap for collection device for vacuum tubes and sampling probe 185 mm

- ▶ In polyethylene
- ▶ Graduated
- ▶ With handle
- ▶ 3000 ml
- ▶ Cap for collection
- ▶ Collecting cannula 20 cm



CAT. NO.	Model	Vol. (ml)	Grad.	Handle	Raw Material	Sale unit
BSL489	Tank Rectangular	3000	X	X	polyethylene	case / 30

## VACUUM URINE CONTAINERS

Vacuum urine container 120 ml in polypropylene with screw cap, with frosted side



CAT. NO.	Volume (ml)	Sterile	Raw Material	Internal packaging	Sale unit
BSC200	120	X	PP	Single packed	case / 250
BSC201	120		PP	Single packed	case / 250
BSC202	120		PP	in Bulk	case / 300

## WATER SAMPLING BOTTLES

Labeled containers in PETG for water sampling. With or without sodium thiosulfate.



CAT. NO.	Volume (ml)	Sodium Thiosulphate	Label	Sterile	Sale unit
BLP001	500	X	X	X	case / 120
BLP002	500		X	X	case / 120
BLP003	1000	X	X	X	case / 72
BLP004	1000		X	X	case / 72

## WASTE CONTAINERS

The BS series consists of three measures of disposable containers and puncture-proof double superimposed shell for the disposal of pointy and sharp waste. They are fitted with indents for the removal of the needle and arranged for a temporary or permanent closure by affixing a seal on the side of the opening. The square base makes the containers extremely stable and easy to assemble thanks to the system of the two shells.



- ▶ In polypropylene
- ▶ Excellent stability
- ▶ Easy connection installation of the two shells
- ▶ Extremely simple to use
- ▶ Temporary and definitive closure with the pin
- ▶ No emission of harmful gases during incineration
- ▶ Indication of the filling level
- ▶ Availability of table stands, wall or adapt to cart
- ▶ Autoclavable



Indents for needle's removal

Temporary closure

Definitive closure

### Rectangular BS series

CAT. NO.	Volume (l)	Dimensions (cm)	Raw Material	Sale unit
BSC300	1.5	11 x 12 x 12	PP	case / 50
BSC301	3.0	14 x 17 x 17	PP	case / 50
BSC302	6.0	22 x 18 x 18	PP	case / 50

The PBS line includes round shape disposable and puncture resistant containers for the disposal of sharp and cutting waste, available in several sizes. The conical shape and the indent on the lid ease the needle disposal and removal, whilst the anti-defluxion flow wings on the lid prevent the waste outflow. All the models have temporary and definite closure and are fitted with solid handle; the most voluminous model is fitted with an ergonomic handle for an easy use.



- ▶ In polypropylene
- ▶ Ergonomic handle for the more spacious models
- ▶ Anti-defluxion wings to prevent the outflow of the waste
- ▶ Mechanism for unhooking insulin needles
- ▶ Maximum filling level indicator
- ▶ Various supports available
- ▶ No emission of any harmful gasses during the inceneration process
- ▶ Autoclavable



Indents for needle's removal

Temporary closure

Definitive closure

### Conical PBS line

CAT. NO.	Volume (l)	Dimensions (cm)	Raw Material	Sale unit
BSC303	0.8	H 18.4 x Ø 10.0	PP	case / 100
BSC304	5.0	H 19.5 x Ø 21.3	PP	case / 55
BSC305	2.0	H 21.0 x Ø 14.0	PP	case / 75
BSC312	12.0	H 31.0 x Ø 24.8	PP	case / 25

The DISPO line is composed of disposable and puncture-proof containers with conical shape bodies. The permanent and inviolable closure that prevents waste leakage and the high container resistance guarantee top quality and safety. All of the models have temporary and permanent closures, a wide opening for the disposal of larger materials, and three indents for the needles and insulin pen removal



- ▶ In polypropylene
- ▶ Excellent stability with suction cuo support use
- ▶ Easy to assemble
- ▶ Practical opening system
- ▶ Indents for needles and insulin pen removal
- ▶ Wide opening for larger material disposal
- ▶ Maximum filling level indicator
- ▶ No emission of any harmful gas during the incineration process
- ▶ Temporary and permanent closure
- ▶ Autoclavable



Easy opening

Notches for removing needles and insulin pens

Wide opening

### Conical DISPO line with rapid closure cap

CAT. NO.	Volume (l)	Dimensions (cm)	Raw Material	Sale unit
BSC306	4.0	H 25.0 x Ø 16.9	PP	case / 40



## TRANSPORT LINE

For more details please visit:

<http://www.biosigma.com/transport-line.html>

## TRANSPORT LINE FOR BIOLOGICAL SAMPLES

### Transport bags Suitable for secondary container CTP

System of transport and protection of biological samples by safety containers. UN3373 - Biological Material Category "B", non autoclavable, sterilizable on cold

- ▶ External in Polyester 600/900 PVC coated.
- ▶ Inner in Nylon 210/210 PVC coated.
- ▶ Semi-rigid structure insulating with padding in Elastolen.
- ▶ Zipper closure.
- ▶ Inside pocket for the cooling element
- ▶ External pocket for documents.
- ▶ Symbols: UN3373 - Biological Material Category "B"
- ▶ Easy transport thanks to light weight and shoulder strap (only reference BS130414)
- ▶ Disinfectable with aqueous solutions of the most common disinfectants
- ▶ Can be sterilized with aqueous solutions of cold sterilants
- ▶ Washable at 40 °C
- ▶ Blue color



BS130413

BS130414

BS720204

CAT. NO.	Suitable for:	Dimensions (cm)	Internal pocket for	Sale unit
BS130413	1 container BS472041	21 x 26 x 36	1 cooling element	1
BS130414	2 containers BS472041	28 x 40 x 36	2 cooling elements	1
BS130415	3 containers BS472041	61 x 38 x 27	3 cooling elements	1
BS720204	4 containers BS472041	35 x 38 x 39	3 cooling elements	1

### Transport Container (CTP) for tubes

Transport container for blood collecting tubes or urine containers. Supplied with foam insert for 78 tubes

- ▶ In polypropylene
- ▶ With silicone sealing
- ▶ With foam insert up 78 tubes
- ▶ With absorbent polymer pad
- ▶ Storage temperature from - 18°C to +50°C
- ▶ Conformity to P650 (ADR 2003, Chap. 4.1.4.1), EN 829



#### Tube Transport Container (CTP)

CAT. NO.	Description	Dimensions (mm)	Sale unit
BS472041	Transport Container (CTP) for 78 tubes	310 x 155 x 180	1

### Duplex racks

Reversible Rack for 84 blood collection tubes or 42 blood collection tubes + 4 for urine containers

- ▶ Suitable for BS472041 Transport Container for tubes (CTP)
- ▶ In Polypropylene
- ▶ Disinfectable and autoclavable up to 121 °C
- ▶ Blue color



#### Reversible rack

CAT. NO.	Description	Dimensions (mm)	Sale unit
BS00102	Reversible Rack for 84 blood collection tubes or 42 blood collection tubes + 4 for urine containers	270 x 125 x 110	1

### Racks in absorbent foam



BS390078

BS390079

#### For BS472041 secondary container in polyurethane

CAT. NO.	Holes	Suitable for:	Transport	Dimensions (cm)	Sale unit
BS390078	78	secondary container BS472041	tubes	28 x 12.8 x 6	1
BS390079	6	secondary container BS472041	urine containers, bottles	28 x 12.8 x 6	1
BS390080	18	secondary container BS472041	histology containers	28 x 12.8 x 6	1

# TRANSPORT LINE

## TRANSPORT LINE IN ACCORDANCE WITH ADR NORMS

### Bags for secondary container transport in accordance with ADR norms

System of transport and protection of biological samples by safety containers, in accordance with ADR European norms. non autoclavable, sterilizable on cold



- ▶ External in Polyester 600/900 PVC coated
- ▶ Inner in Nylon 210/210 PVC coated
- ▶ Semi-rigid structure insulating with 8 mm padding in Elastolen
- ▶ Zipper closure
- ▶ Inside pocket for the cooling element
- ▶ External pocket for documents
- ▶ Symbols: UN3373 - Biological Material Category "B"
- ▶ Disinfectable with aqueous solutions of the most common disinfectants
- ▶ Can be sterilized with aqueous solutions of cold sterilants
- ▶ Washable at 40 °C
- ▶ Blue color

CAT. NO.	Suitable for:	Dimensions (cm)	Internal pocket for	Sale unit
BS720201	1 container BS472040 40 tubes	28 x 18 x 21	1 cooling element	1
BS720202	2 containers BS472040 80 tubes	32 x 30 x 22	2 cooling elements	1
BS720203	3 containers BS472040 120 tubes	43 x 30 x 20	3 cooling elements	1
BS720206	6 containers BS472040 240 tubes With shoulder strap	42 x 30 x 38	4 cooling elements	1
BS720205	1 container BS800110 12 tubes	Ø12 x 15	-	1

### VACUETTE® Transport Box (VTB)

Secondary container for biological sample transport. The VACUETTE® Transport Box ensure the safe transport of sample material from the collection point right up to analysis in the laboratory. The VACUETTE® Transport Box can store 40 tubes

- ▶ In polypropylene
- ▶ With silicone sealing
- ▶ With foam insert for up to 40 tubes
- ▶ With absorbent polymer pad
- ▶ Storage temperature from - 18°C to +50°C
- ▶ In accordance with ADR/RID, IATA-DG, ICAO-Code and IMDG-Code



VACUETTE® Transport Box (VTB)

CAT. NO.	Description	Dimensions (mm)	Sale unit
BS472040	Secondary container for biological sample transport	270 x 125 x 180	1

### VACUETTE® Transport Container (MTC)

VACUETTE® Transport Containers ensure the safe transport of biological substance (UN 3373) CATEGORY B from the collection point right up to analysis in the laboratory. The VACUETTE® Transport Containers can store twelve tubes and are available with or without shipping box.

- ▶ Screw cap container for 12 tubes in polypropylene
- ▶ For tubes of 13x75, 13x100, 16x100 mm with foam insert
- ▶ Non sterile
- ▶ With absorbent pad
- ▶ Foam insert with 12 places for the primary containers
- ▶ In accordance with ADR/RID, IATA-DG, ICAO-Code and IMDG-Code



Cylindrical container for 12 tubes

CAT. NO.	Description	Dimensions (mm)	Sale unit
BS800110	Container for 12 tubes	Ø113 h 1180	1

### Racks in absorbent foam for secondary containers

For BS800110 secondary container in polyurethane

CAT. NO.	Holes	Suitable for:	Transport	Dimensions (cm)	Sale unit
BS800101	12	BS800110	tubes	Ø 10.5 x 6.8	1

For BS472040 secondary container in polyurethane

CAT. NO.	Holes	Suitable for:	Transport	Dimensions (cm)	Sale unit
BS472007	40	for secondary container BS472040	tubes	21,8 x 9 x 6.8	1
BS472008	3	for secondary container BS472040	urine containers, bottles	21,8 x 9 x 6.8	1
BS472009	8	for secondary container BS472040	urine containers, bottles	21,8 x 9 x 6.8	1





## TRANSPORT LINE FOR CHEMOTHERAPEUTICS SAMPLES

### Transport bags for chemotherapeutics samples, suitable CTP

- ▶ In conformity with the guidelines of the Official Gazette 236/99 for the transport of anticancer drugs (measure 5 August 1999)
- ▶ External in Polyester 600/900 PVC coated
- ▶ Inner in Nylon 210/210 PVC coated
- ▶ Semi-rigid structure insulating with 8 mm padding in Elastolen
- ▶ Zipper closure
- ▶ Inside pocket for the cooling element
- ▶ External pocket for documents
- ▶ Easy transport thanks to light weight and shoulder strap (only reference BS130414/C)
- ▶ Disinfectable with aqueous solutions of the most common disinfectants
- ▶ Can be sterilized with aqueous solutions of cold sterilants
- ▶ Washable at 40 °C
- ▶ Blue color



### Transport Container (CTP) for chemotherapeutics samples

Transport container for chemotherapeutics samples, supplied with foam insert for 78 tubes

- ▶ In conformity with the guidelines of the Official Gazette 236/99 for the transport of anticancer drugs (measure 5 August 1999)
- ▶ In polypropylene
- ▶ With silicone sealing
- ▶ Ermetic closure
- ▶ With foam insert up 78 tubes
- ▶ With absorbent polymer pad
- ▶ Storage temperature from - 18°C to +50°C



CAT. NO.	Capacity	Dimensions (cm)	Internal pocket for	Sale unit
BS130413/C	1 container BS472041/C	21 x 26 x 36	1 cooling element	1
BS130414/C	2 containers BS472041/C	28 x 40 x 36	2 cooling elements	1
BS130415/C	3 containers BS472041/C	61 x 38 x 27	3 cooling elements	1
BS720204/C	4 containers BS472041/C	35 x 38 x 39	3 cooling elements	1

CAT. NO.	Capacity	Dimensions (cm)	Sale unit
BS472041/C	Transport Container (CTP) for 78 tubes	310 x 155 x 180	1

### Duplex racks for BS472041/C

Reversible Rack for 84 blood collection tubes or 42 blood collection tubes + 4 for urine containers

- ▶ Suitable for BS472041 Transport Container for tubes (CTP)
- ▶ In Polypropylene
- ▶ Disinfectable and autoclavable up to 121 °C
- ▶ Blue color



Reversible rack

CAT. NO.	Description	Dimensions (mm)	Sale unit
BS00102	Reversible Rack for 84 blood collection tubes or 42 blood collection tubes + 4 for urine containers	270 x 125 x 110	1

### Racks in absorbent foam



For BS472041/C secondary container in polyurethane

CAT. NO.	Holes	Suitable for:	Transport	Dimensions (cm)	Sale unit
BS390078	78	secondary container BS472041/C	tubes	28 x 12.8 x 6	1
BS390079	6	secondary container BS472041/C	urine containers, bottles	28 x 12.8 x 6	1
BS390080	18	secondary container BS472041/C	histology containers	28 x 12.8 x 6	1

## TERTIARY CONTAINERS FOR BLOOD COMPONENTS

Bags for blood component and biological sample transportation, suitable for blood- bag secondary containers

Designed and manufactured for the transport of units of whole and worked blood characterized by:

- ▶ Very durable material that ensures a good resistance to knocks and accidental drops
- ▶ Padding that allows the maintenance of the initial internal temperature for 3-4 hours depending on the outside temperature
- ▶ Inside pocket for the cooling element
- ▶ Shoulder strap for easy transport by operators
- ▶ Prints in accordance with ADR (UN 3373, Biological Material category B, Transport Blood components)



Tertiary container for blood components transport

CAT. NO.	Suitable for:	Dimensions (cm)	Internal pocket for	Sale unit
BS720203/P	1 bag BS472045	43 x 34 x 20	1 cooling element	1
BS720205/P	1 bag BS472045	43 x 34 x 32	1 cooling element	1

## Transport of blood bags

Bag designed for the transport of units of whole or worked blood characterized by:

- ▶ A double airtight seal that prevents the spreading of biological fluids
- ▶ Transparent material that allows the visualization of the contents, allowing the operator to monitor any broken blood bags
- ▶ Resistant material that provides good protection of the contents in the event of shocks or accidental falls
- ▶ Suitable for tertiary container BS720203/P and BS720205/P



CAT. NO.	Capacity	Dimensions (mm)	Sale unit
BS472045	20 whole blood bags or up to 40 worked blood bags	360 x 250 x 500	1
BS600601/S	6 whole blood bags or up to 15 worked blood bags	260 x 190 x 262	1

## ACCESSORIES

### Cooler Elements

Cool pad for transport containers



BS4800



BS4900

CAT. NO.	Description	Dimensions (mm)	Weight Kg	Sale unit
BS4800	Cool Pad for VTC (BS720205)	Ø 110	0,05	1
BS4900	Cooler Pack for VTB (BS472040)	L220 x W120 x H11	0,245	1

### Refrigerated container for single tubes

Refrigerated container for maintaining and transporting blood at original conditions, 16 x 100 mm.



CAT. NO.	Description	Dimensions (mm)	Internal packaging	Sale unit
BSM570	Refrigerated container	16 x 100	4	12

### Specimen transport bags

- ▶ Transparent polyethylene
- ▶ 7 different colours available
- ▶ Large printed biohazard graphic and writing area
- ▶ Double pocket to keep the paperwork separate from the container
- ▶ Reclosable zipper seal
- ▶ CE marked



CAT. NO.	Colour	Dimensions (cm)	Internal packaging	Sale unit
BSA2401	transparent	16 x 16 x 23h	100	1000
BSA2101	yellow	16 x 16 x 23h	100	1000
BSA2201	green	16 x 16 x 23h	100	1000
BSA2301	light blue	16 x 16 x 23h	100	1000
BSA2461	red	16 x 16 x 23h	100	1000
BSA2601	orange	16 x 16 x 23h	100	1000
BSA2701	pink	16 x 16 x 23h	100	1000
BSA2801	violet	16 x 16 x 23h	100	1000

### Security bags

Tamper evident security bags  
235x320+30+30 mm

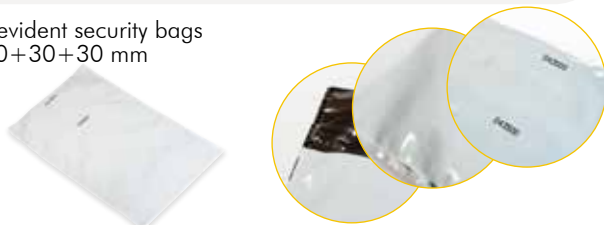

CAT. NO.	Colour	Dimensions (cm)	Sale unit
BSA2350	White	235x320+30+30	500

## FIRST AID BAGS

### First aid bag with 4 external pockets

- ▶ External material: Cordura 1000
- ▶ Internal material: Nylon 210/210, PVC
- ▶ Shoulder straps and handles: Polyester 600/900, PVC
- ▶ Dimensions: ± 45 x 20 x 45h
- ▶ Weight: ± 3 Kg
- ▶ 4 external pockets
- ▶ Zipper closure
- ▶ Reflective strips
- ▶ Window for frontal Logo



CAT. NO.	Description	Dimensions (cm)	Sale unit
BS2402	First aid bag with 4 external pockets	45 x 20 x 45	1

### First aid bag with 5 external pockets and 3 internal pockets

- ▶ External material: Cordura 1000
- ▶ Internal material: Nylon 210/210, PVC
- ▶ Shoulder straps and handles: Polyester 600/900, PVC
- ▶ Dimensions: ± 50 x 30 x 60h
- ▶ Weight: ± 3 Kg
- ▶ 5 external pockets + 3 internal pockets
- ▶ Zipper closure
- ▶ Anatomical backrest
- ▶ Double seams



CAT. NO.	Description	Dimensions (cm)	Sale unit
BS2401	First aid bag with 5 external pockets and 3 internal pockets	50 x 30 x 60	1

### Non-rigid container

- ▶ Material: Nylon 210/210, PVC, transparent Kristal
- ▶ Dimensions: ± 30 x 9 x 16h
- ▶ Zipper closure
- ▶ One transparent face
- ▶ One Velcro face



CAT. NO.	Colour	Dimensions (cm)	Sale unit
BS2405G	yellow	50 x 30 x 60	1
BS2405V	green	50 x 30 x 60	1
BS2405B	blue	50 x 30 x 60	1
BS2405A	orange	50 x 30 x 60	1
BS2405R	red	50 x 30 x 60	1



## HEALTH AND SAFETY

For more details please visit:  
<http://www.biosigma.com/health-and-safety.html>

### PARAFILM



CAT. NO.	Dimensions (cm x m)	Description	Sale unit
090261	5 x 75	Parafilm ultra-expandable closing film tape	1
090260	10 x 38	Parafilm ultra-expandable closing film tape	1
090997	-	Distributor cutter parafilm	1
090998	10 x 75	Maxi-dispenser for Parafilm ultra-expandable closing film	1
090999	50 x 15	Maxi-roll of Parafilm ultra-expandable closing film	1

### GEN-X Nitrile gloves

- ▶ Ambidextrous
- ▶ Colours blue violet
- ▶ Powder free
- ▶ Length 240 mm
- ▶ In compliance with EN455
- ▶ Nitrile gloves, textured fingertips



CAT. NO.	Description	Size	Sale unit
603501	GEN-X nitrile gloves	XS	100
603502	GEN-X nitrile gloves	S	100
603503	GEN-X nitrile gloves	M	100
603504	GEN-X nitrile gloves	L	100
603505	GEN-X nitrile gloves	XL	100

## NITRILE GLOVES

- ▶ Nitrile gloves without powder not sterile
- ▶ Case 200 pcs, carton 2000 pcs. (10x200)
- ▶ EN455 Parts 1, 2, 3 & 4 – EC marked in compliance with European Medical Device Directive 93/42/EEC (CE Class I non sterile)
- ▶ EN374 (03) 1/2/3; EN420 (10); EN388 (03) – CE 0465 marked in compliance with PPE
- ▶ Directive 89/686/EEC (PPE III Category Complex Design)
- ▶ ASTM D6319
- ▶ ASTM F1670 - F1671
- ▶ EN980
- ▶ EN ISO 15223-1
- ▶ Ambidextrous shape with straight fingers
- ▶ Reinforced cuff with elastic border
- ▶ Absence of powder with consequent elimination of all the problems connected with the use of the same.



CAT. NO.	Size	Internal packaging	Sale unit
BSIO80	XS	200	2000
BSIO81	S	200	2000
BSIO82	M	200	2000
BSIO83	L	200	2000
BSIO84	XL	200	2000

## LATEX GLOVES

Latex powder free gloves

- ▶ EN 455 parts 1, 2, 3 & 4
- ▶ EN420, EN388, EN374 parts 1, 2 & 3
- ▶ ASTM D3578
- ▶ ASTM F1671
- ▶ Directive 89/686/EEC
- ▶ EC marked in compliance with European Medical Device Directive 93/42/EEC
- ▶ Non sterile



CAT. NO.	Size	Internal packaging	Sale unit
BSIO30	S	100	1000
BSIO31	M	100	1000
BSIO32	L	100	1000
BSIO33	XL	95	950

## CRYOGENIC GLOVES

Protect yourself from extreme temperatures. Gloves which protect from very high or low temperatures, with an outer layer made of nylon and an interior made of a cotton - polyester complex protected by a polyefine film.

- ▶ Soft, comfortable, warm, even after prolonged exposure to cold
- ▶ Machine washable and dryable

5 finger glove in 4 lengths:

- ▶ Wrist: 30 cm
- ▶ Mid-forearm: 38 cm
- ▶ Elbow: 50 cm
- ▶ Shoulder: 68 cm

Characteristics of the standard model:

- ▶ Freezer at very low temperatures
- ▶ Cold room
- ▶ Dry ice handling

Characteristics of the impervious model:

- ▶ Applications in a liquid nitrogen atmosphere or environment
- ▶ Coolant bars
- ▶ Cryogenic grinding

NB: Never immerse the glove directly in liquid nitrogen.



	STANDARD MODEL				IMPERVIUS MODEL				Sale unit
	SMALL (S)	MEDIUM (M)	LARGE (L)	EXTRA LARGE (XL)	SMALL (S)	MEDIUM (M)	LARGE (L)	EXTRA LARGE (XL)	
5 fingers 30 cm	035501	035502	035503	035504	035517	035518	035519	035520	1
5 fingers 38 cm	035505	035506	035507	035508	035521	035522	035523	035524	1
5 fingers 50 cm	035509	035510	035511	035512	035525	035526	035527	035528	1
5 fingers 68 cm	035513	035514	035515	035516	035529	035530	035531	035532	1

- ▶ For use of material stored in liquid nitrogen or at low temperatures
- ▶ Very good insulation, thinner gloves offering excellent dexterity
- ▶ Synthetic fibre for improved flexibility
- ▶ Water resistant

- ▶ Coating "waterproof"
- ▶ With suspension ring
- ▶ EC marking

Cold protection gloves

	Gloves L. 37 cm	Gloves L. 50 cm	Gloves L. 60 cm	Sale unit
SMALL (S)	446658	446662	446670	1
MEDIUM (M)	446659	446663	446671	1
LARGE (L)	446660	446664	446672	1
EXTRA LARGE (XL)	446661	446665	446673	1





## GINECOLOGY AND FERTILITY

For more details please visit:

<http://www.biosigma.com/ginecology-and-fertility.html>

## SEMEN COLLECTION

The KIT FOR FERTILITY is a disposable devices used for the collection of semen sample from the patient to the laboratory and for analysis in vitro. Reserved for the medical and technical personnel with the necessary qualifications and professional preparation.

- ▶ Funnel. (A)
- ▶ Plug for funnel. (B).
- ▶ Graduated test tubes, vol. 15ml. (C)
- ▶ Screw cap for tube. (D)
- ▶ Label for test tube. (E)
- ▶ Support for tube. (F)



CAT. NO.	Description	Sale unit
BSC740	Ejaculate collecting device with test tube 15 ml, label, stopper, single packed, sterile	40

## SPRAY FOR CITOLOGY

Kito-Fix Spray for cytology



CAT. NO.	Description	Sale unit
BS1109	Kito-Fix spray for cytology	1

## EJACULATE SLIDE-READ BOX

Ejaculate slide-read box composed of 25 slides of 2 determination each and 50-grid cover slips. Sample dilution is not required.

- ▶ For sperm counts in undiluted specimens
- ▶ Counting grid laser-etched into its surface
- ▶ Eliminates cleaning and minimizes clinician exposure to body fluids
- ▶ The slide consists of two chambers (for dual determinations), with a depth of 20 µm each



CAT. NO.	Description	Internal packaging	Sale unit
BSC729	Ejaculate slide-read	50	1

## VAGINAL SPECULUM

Sterile central pin vaginal speculum, single packed, in polystyrene.

- ▶ Sterile
- ▶ Single packed
- ▶ in Polystyrene
- ▶ With central pin



CAT. NO.	Size	Internal packaging	Sale unit
BSM240	Small	single packed	200
BSM241	Medium	single packed	200
BSM242	Large	single packed	120

## AYRE SPATULES

Ayre spatule perfectly suited for sampling exocervical (outside of the cervix) for precocious diagnosis of uterus cancer

- ▶ Sterile
- ▶ Single packed
- ▶ in Polystyrene or wood
- ▶ Latex free
- ▶ Dimensions 180 mm



CAT. NO.	Material	Dim. (mm)	Sterile	Internal packaging	Sale unit
BSM018	polystyrene	180	X	Single packed	500
BSM016	wood	180	X	Single packed	500

## CYTOBRUSHES

Disposable hendocervical sampling brush

- ▶ Also available sterile single packed
- ▶ 210 mm Length
- ▶ CE Marked product - manufactured in compliance with 93/42/EEC Directive Annex V
- ▶ Synthetic bristles non-allergic atraumatic



CAT. NO.	Sterile	Internal packaging	Sale unit
BSM009	X	single packed	1000
BSM008	-	-	50



# HEMATOLOGY

For more details please visit:  
<http://www.biosigma.com/hematology.html>

## BIOBLOOD DEVICES

### TYPESAFE™ in PVC

TYPESAFE™ in PVC segment sampling device

- ▶ Allows cells to pass through easily
- ▶ Ribbed edges allows for easy handling with gloved hands
- ▶ Fits into 10 and 12 ml tube sizes
- ▶ Wide mouth fits most standard segment sizes
- ▶ Top and bottom of device are easily identified by technicians in the blood bank
- ▶ Highlights: FDA Cleared
- ▶ Single, in-vitro diagnostic use



TYPESAFE™ in PVC segment sampling device

CAT. NO.	Internal packaging	Sale unit
BSA038TX	bag / 500	case / 1000

### Drop slide system

Drop slide system hematological dispenser for smear (usable to pearce vacuum tubes stopper).

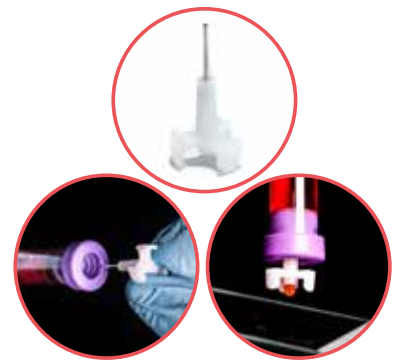

Drop slide system

CAT. NO.	Color	Sale unit
BSS700	white	case / 1000

### BREAKLOT STICK



Breaklot stick in polystyrene

CAT. NO.	Color	Internal packaging	Sale unit
BSA066	white	bag / 1000	case / 3000

### BLOOD GROUPING STRIPS



Blood grouping strip

CAT. NO.	Dimensions (mm)	Places	Sale unit
BSA039	L 17.30 H 4.50	12	case / 400
BSA037	L 17.30 H 4.50	10	case / 250



## SYRINGES FOR BLOOD COLLECTION

Made of transparent medical polypropylene with a thermoplastic elastomer seal, latex-free; FLOMAX stainless steel needle with a much thinner wall than standard needles, less painful for the patient. The penetration of the needle into the tissues is gentle and with minimal trauma, thanks to the special sharpening of the triple-faceted needle.

- ▶ Colour code needle cone
- ▶ Black graduated scale, large and well visible
- ▶ Latex Free
- ▶ Sterilized with ethylene oxide, valid for 60 months
- ▶ Packed in single blister
- ▶ EC marked in compliance with European Medical Device Directive 93/42/EEC.

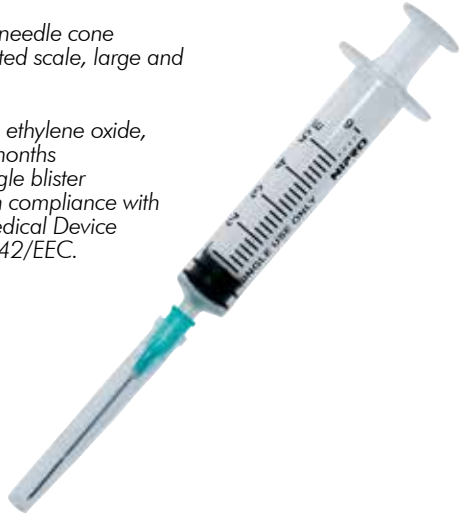

Sterile syringe

CAT. NO.	Description	Needle (G)	Sale unit
BSS130	20 ml (gr:1 -20ml) Eccentric luer slip tip	-	50
BSS131	50-60 ml (gr:1 -50/60ml) Eccentric luer slip tip	-	30
BSS133 /A	Insulina 100U 1 ml Centr. luer slip tip	26G 1/2" beige	100
BSS134	2-2,5 ml (gr:0,1 -2,5/3ml) Centr. luer slip tip	22G 1-1/4" black	100
BSS135	2-2,5 ml (gr:0,1 -2,5/3ml) Centr. luer slip tip	-	100
BSS136	5 ml (gr:0,2 -5/6ml) Centr. luer slip tip	-	100
BSS137	10 ml (gr:0,2 -11/12ml) Eccentric luer slip tip	-	100
BSS140	5 ml (gr:0,2 -5/6ml) Centr. luer slip tip	21G 1-1/2" green	100
BSS141	10 ml (gr:0,2 -11/12ml) Centr. luer slip tip	21G 1-1/2" green	100

## BUTTERFLY NEEDLE

- ▶ Tube length 30 cm
- ▶ Sterile
- ▶ Pyrogen free
- ▶ Latex free
- ▶ Individually wrapped



Sterile butterfly needle

CAT. NO.	Needle (G)	Color	Sale unit
BSS250	21	green	50
BSS251	23	light blue	50
BSS252	25	orange	50

## TOURNIQUETS

- ▶ Medical device Class I
- ▶ Not sterile
- ▶ Internal diameter: mm  $6 \pm 5\%$
- ▶ External diameter: mm  $8 \pm 5\%$
- ▶ Ce marked



CAT. NO.	Description	Color	Dimensions (mm)	Sale unit
ABS022	Round tourniquet in natural latex with flanges at the ends	yellow	$350 \pm 5\%$	100

## STERILE NEEDLE



Hypodermic sterile needle

CAT. NO.	Description	Color	Sale unit
BSS230R	18 GA x 1 1/2	pink	100
BSS231R	19 GA x 1 1/2	brown	100
BSS232R	20 GA x 1 1/2	yellow	100
BSS233R	21 GA x 1 1/2	green	100
BSS234R	22 GA x 1 1/2	black	100
BSS235R	23 GA x 1 1/2	light blue	100
BSS236R	25 GA x 5/8	blue	100
BSS237R	26 GA x 1/2	beige	100
BSS238R	27 GA x 3/4	grey	100

## SAFE TOUCH BUTTERFLY NEEDLE

- ▶ Latex free
- ▶ With security device
- ▶ Sterile
- ▶ Individually wrapped

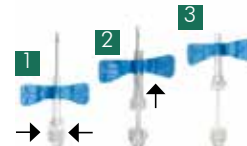

Safe Touch sterile butterfly needle

CAT. NO.	Needle (G)	Tube length	Color	Sale unit
BV100	19G x 3/4" (19mm)	300 mm	beige	50
BV101	21G x 3/4" (19mm)	300 mm	green	50
BV102	22G x 3/4" (19mm)	300 mm	black	50
BV103	23G x 3/4" (19mm)	300 mm	blue	50
BV104	25G x 3/4" (19mm)	300 mm	orange	50

## 96-WELL MICROTITER PLATES IN POLYSTYRENE

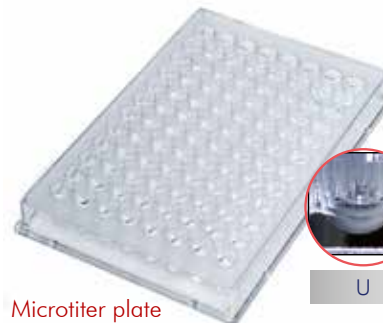

Microtiter plate

CAT. NO.	Sale unit	CAT. NO. STERILE	Sale unit	Bottom	Wells
BSD001	case / 50	BSD010	case / 300	U	96
BSD002	case / 50	BSD011	case / 300	V	96
BSD003	case / 50	BSD012	case / 300	flat	96
BSD013	case / 50	BSD013/S	case / 300		Cover for microtiter plate



Plate adhesive film

CAT. NO.	Dimensions (mm)	Material	Sale unit
106571	131 x 81.3	Polyethylene	case / 100
106570	131 x 81.3	Aluminium	case / 100





**Cat.No. Index**

# Cat.No. Index

REF.	Pag.	REF.	Pag.	REF.	Pag.	REF.	Pag.	REF.	Pag.	REF.	Pag.
000972	75	017261	42	035515	25	039840	88	062629	32	134000CL	52
000973	75	017370CL	52	035515	109	039841	88	064201	88	134750CL*	52
02844	44	017802	42	035516	25	039842	88	064202	88	134760CL*	52
010153	39	017867	42	035516	109	039843	88	064203	88	136590	45
010154B	39	017868	42	035517	25	039844	88	064204	88	136590	45
010158	42	021970	44	035517	109	039845	88	068509	74	138790	42
010159	41	023080	44	035518	25	039846	88	068511	74	138800	45
010161CL	24	023190	41	035518	109	039847	88	068512	74	138820	45
010162CL	24	023190A	41	035519	25	039848	88	076058	78	138870	45
010163	24	026190	44	035519	109	039849	88	076059	78	138900	45
010164	24	027110CL	52	035520	25	039850	88	076060B	78	141397	33
010179	24	027120CL	52	035520	109	039851	88	076084B	78	174370	45
010181	24	028123	23	035521	25	040728	71	87112E	67	320532	33
010183CL	24	028124	23	035521	109	040729	71	87122E	67	320532	88
010184CL	24	028200CL	52	035522	25	040730	71	87123E	67	320533	33
010185	24	030131	24	035522	109	040731	71	87176E	67	320533	88
010186	24	030132	24	035523	25	040732	71	87177E	67	321009	75
010207	41	030133	24	035523	109	042820	78	087804	49	391057	74
010208	42	030134	24	035524	25	042821	78	087805	49	391058	74
010300	56	030135	24	035524	109	042822	78	087806	49	391070	35
010310	56	030136	24	035525	25	042823	78	087807	49	391071	35
010320	56	030137	24	035525	109	042824	78	090260	108	391072	35
010330	56	030138	24	035526	25	045405	42	090261	108	391073	35
010340	56	030139	24	035526	109	045430	89	090997	108	391074	87
010350	56	030560ACL	52	035527	25	045431	89	090998	108	391075	87
010360	56	030570ACL	52	035527	109	045432	89	090999	108	391076	87
010370	56	032230CL	52	035528	25	045433	89	092391	26	391077	87
010380	56	032240CL	52	035528	109	045434	89	092392	26	391078	87
010390	56	032250CL	52	035529	25	045436	89	092393	26	391079	87
010400	56	032260CL	52	035529	109	045437	89	097800	49	391080	87
010410	56	035100ACL	52	035530	25	045438	89	097801	49	391081	87
010420	56	035200CL	52	035530	109	045439	89	097802	49	391082	87
010450	56	035210CL	52	035531	25	045440	89	097803	49	391083	87
010460	56	035220CL	52	035531	109	045441	89	097804	49	391084	87
010510	56	035230CL	52	035532	25	045442*	89	097805	49	391085	87
011670	45	035240CL	52	035532	109	045443	89	097819	49	391086	87
014200CL	52	035260CL	52	035800	44	045464	35	106524	44	391087	87
014210CL	52	035501	25	035900	44	045465	43	106570	113	391088	87
014220CL	52	035501	109	036060CL	52	045466	43	106571	113	391089	87
015020CL	52	035502	25	036060TCL	52	045467	43	112740	56	391090	87
015160A	41	035502	109	036164	75	045468	43	112750	56	391091	87
016000	42	035503	25	037559	89	045469	43	112760	56	391092	87
016000F	42	035503	109	037560	89	045470	43	112770	56	391093	87
016001	42	035504	25	037561	89	045471	43	112780	56	446658	25
016139	41	035504	109	037562	89	045472	43	112790	56	446658	109
016147	41	035505	25	037563	89	045473	43	116280	42	446659	25
016155	41	035505	109	037564	89	045474	43	116380	42	446659	109
016164	42	035506	25	037565	89	045475	43	130340CL	52	446660	25
016166	42	035506	109	037572	89	045476	43	130510CL	52	446660	109
016167	42	035507	25	037579	35	045546	43	130510TCL	52	446661	25
016303	42	035507	109	037580	35	045798	74	131000C	38	446661	109
016389	42	035508	25	037640CL	52	045799	74	131002C	38	446662	25
016511	42	035508	109	037640TCL	52	048021	89	131004C	38	446662	109
016512	42	035509	25	037660CL	52	048021B	89	131006C	38	446663	25
016513	42	035509	109	037660TCL	52	049730	88	131008C	38	446663	109
016514	42	035510	25	037877	78	049731	88	131010C	38	446664	25
016517	42	035510	109	037990	42	049732	88	131012C	39	446664	109
016518	42	035511	25	038000CL	52	055029	25	131019C	39	446665	25
016561	42	035511	109	038000TCL	52	055030	25	131020C	39	446665	109
016562	42	035512	25	038780	42	060974	33	131024C	39	446670	25
016950	41	035512	109	038787	43	060975	33	131028C	39	446670	109
016950A	41	035513	25	039620	45	062586	33	131046C	39	446671	25
017030	41	035513	109	039837	88	062589	33	131048C	39	446671	109
017030A	41	035514	25	039838	88	062627	32	131050C	39	446672	25
017239	42	035514	109	039839	88	062628	32	131052C	39	446672	109

# Cat.No. Index

REF.	Pag.	REF.	Pag.	REF.	Pag.	REF.	Pag.	REF.	Pag.	REF.	Pag.
446673	25	750218	24	933015	32	ABS120HPA	48	BS720205	104	BSA84	59
446673	109	750219	24	933022	33	ABS121HPA	48	BS720205/P	106	BSA85	59
490010	45	750220	24	933023	33	ABS122HPA	48	BS720206	104	BSA86	59
542000	38	750221	24	949000	88	ABS123HPA	48	BS800110	104	BSA88	61
542040	38	750222	24	949001	88	ABS124HPA	48	BSA001	62	BSA094	59
542070	38	750223	24	949002	88	ABS125HPA	48	BSA001M	62	BSA096	59
603501	108	750224	24	949003	88	ABS126HPA	48	BSA002	62	BSA098	59
603502	108	750225	24	949004	88	ABS127HPA	48	BSA002M	62	BSA102	61
603503	108	750226	24	949005	88	ABS128HPA	48	BSA05.010.1000	30	BSA108	59
603504	108	750227	24	949006	88	ABS129HPA	48	BSA05.020.0500	30	BSA0269	34
603505	108	760201	39	949007	88	ABS131HPA	48	BSA15.010.1000	30	BSA0269/AM	34
658170	38	760205	39	949008	88	ABS132HPA	48	BSA15.020.0500	30	BSA300	63
658175	38	760214	39	949009	88	ABS133HPA	49	BSA20.008.1000	30	BSA301	63
660160	38	760215	39	949010	88	ABS135HPA	49	BSA20.016.0500	30	BSA302	63
660175	38	765247	44	949011	88	ABS136HPA	49	BSA021	34	BSA303	63
661160	38	765248	44	949012	88	ABS1210HPA	48	BSA022	34	BSA304	63
661175	38	779912	21	949013	88	ABS1240HPA	48	BSA022/AM	34	BSA305	63
690160	38	779913	21	949014	88	ABS1241HPA	48	BSA022/BLU	34	BSA0592	85
690170	38	779916	21	949015	88	ABS1261HPA	48	BSA022/G	34	BSA0594	85
690175	38	779917	21	949016	88	ABS1290HPA	48	BSA022/RA	34	BSA0594/P	85
712201	45	779918	21	949017	88	ABS1310HPA	48	BSA022/V	34	BSA636S	61
713110	55	779919	21	978253	38	ABS1311HPA	48	BSA024	59	BSA646S	61
713111	55	779920	21	999059B	78	BLP001	100	BSA024/BLU	59	BSA651	61
713112	55	779940	21	999060B	78	BLP002	100	BSA024/G	59	BSA655	60
713113	55	779944	22	4949032	21	BLP003	100	BSA024/RA	59	BSA656	60
713114	54	789001B	86	4949033	21	BLP004	100	BSA024/V	59	BSA658	60
713115	54	789002	86	4949035	21	BS00102	103	BSA026	34	BSA659	60
713116	54	789008	86	4949036	21	BS00102	105	BSA026/AM	34	BSA731	61
713117	54	789009	86	4949038	20	BS2401	107	BSA027	60	BSA2101	107
713118	54	830105	26	4949039	20	BS2402	107	BSA027	61	BSA2201	107
713119	54	830106	26	4949040	20	BS2405A	107	BSA029	61	BSA2301	107
713120	55	830107	26	4949041	20	BS2405B	107	BSA030	61	BSA2350	107
713121	55	830108	26	4949042	20	BS2405G	107	BSA031S	59	BSA2401	107
713128	55	830159	26	4949043	20	BS2405R	107	BSA032	61	BSA2461	107
713129	55	840515	35	4949044	20	BS2405V	107	BSA037	112	BSA2601	107
713130	54	840516	35	4949045	20	BS4800	107	BSA038TX	112	BSA2701	107
713131	54	840518	35	4949046	20	BS4900	107	BSA039	112	BSA2801	107
713135	54	840519	35	4949047	20	BS130413	103	BSA045	61	BSA5258	61
713136	54	840520	35	4949048	20	BS130413/C	105	BSA046	61	BSC105	99
713137	54	840521	35	4949050	20	BS130414	103	BSA50.006.0500	31	BSC123	99
713138	54	840522	35	4949051	20	BS130414/C	105	BSA50.030.0100	31	BSC124	99
713139	54	840523	35	4949052	20	BS130415	103	BSA059V	85	BSC128	99
713140	54	840524	35	4949053	20	BS130415/C	105	BSA059V/P	85	BSC132	99
713147	55	840525	35	4949054	20	BS390078	103	BSA060	85	BSC146	99
713148	55	840526	35	4949055	20	BS390078	105	BSA062	86	BSC148	99
713149	55	840527	35	4949056	20	BS390079	103	BSA062/AZ	86	BSC160	99
713150	55	840528	35	4949057	20	BS390079	105	BSA062/B	86	BSC163	99
713151	55	840529	35	4949058	20	BS390080	103	BSA062/BLU	86	BSC195	99
713162	55	840530	35	4949059	20	BS390080	105	BSA062/G	86	BSC198	99
750202	24	861000	46	4949060	20	BS400200	46	BSA062/RA	86	BSC199	99
750203	24	861001	46	4949061	20	BS400201	46	BSA062/RO	86	BSC200	84
750204	24	861002	46	4949062	20	BS472007	104	BSA062/V	86	BSC200	100
750205	24	861003	46	4949063	20	BS472008	104	BSA063	86	BSC201	84
750206	24	861005	46	4949064	20	BS472009	104	BSA063/AZ	86	BSC201	100
750207	24	861006	49	4949065	20	BS472040	104	BSA063/B	86	BSC202	84
750208	24	861055	49	4949066	20	BS472041	103	BSA063/BLU	86	BSC202	100
750209	24	900509	75	4949067	20	BS472041/C	105	BSA063/G	86	BSC253	99
750210	24	900510	75	4949068	20	BS472045	106	BSA063/RA	86	BSC258	99
750211	24	900511	75	4949069	20	BS600601/S	106	BSA063/RO	86	BSC300	101
750212	24	900512	75	4949070	20	BS720201	104	BSA063/V	86	BSC301	101
750213	24	900514	75	4949071	20	BS720202	104	BSA066	112	BSC302	101
750214	24	913077	26	4949072	21	BS720203	104	BSA69	61	BSC303	101
750215	24	913078	26	4949199	20	BS720203/P	106	BSA73	61	BSC304	101
750216	24	913081	26	ABS022	113	BS720204	103	BSA74	61	BSC305	101
750217	24	913082	26	ABS119HPA	48	BS720204/C	105	BSA77	61	BSC306	101

# Cat.No. Index

REF.	Pag.	REF.	Pag.	REF.	Pag.	REF.	Pag.	REF.	Pag.	REF.	Pag.
BSC312	101	BSF2054/CS	84	BSM084	81	BSM58071B1D/AZ	15	BSP082	85	BSV120	77
BSC660	99	BSF2054/K	84	BSM085	81	BSM58071B1D/G	15	BSP083	85	BSV121	77
BSC665	99	BSI030	109	BSM086	81	BSM58071B1D/RO	15	BSP213	87	BSV0121	91
BSC729	111	BSI031	109	BSM087	81	BSM58071B1D/V	15	BSP217	87	BSV0123P	91
BSC740	111	BSI032	109	BSM088	81	BSM58071B/AZ	14	BSP277	87	BSV134	57
BSC2511	100	BSI033	109	BSM089	81	BSM58071B/G	14	BSP278	87	BSV135	57
BSC2512	100	BSI080	109	BSM090	81	BSM58071B/RO	14	BSP300	60	BSV136	57
BSC2520	100	BSI081	109	BSM091	81	BSM58071B/V	14	BSP2501	82	BSV137	57
BSC2521	100	BSI082	109	BSM093	81	BSM58100/AZ	14	BSR001	50	BSV140	57
BSC2522	100	BSI083	109	BSM094	81	BSM58100/B	14	BSR002	50	BSV143	57
BSC2524	100	BSI084	109	BSM200	78	BSM58100/G	14	BSR003	50	BSV150	57
BSC2525	100	BSI101	73	BSM212	78	BSM58100/RO	14	BSR004	50	BSV150	97
BSC2527	100	BSI102	71	BSM215	78	BSM58100/V	14	BSR007	50	BSV180	57
BSD001	113	BSI103	71	BSM220	78	BSM580481	19	BSR008	50	BSV1200	77
BSD002	113	BSI104	70	BSM230	78	BSM580612D/AZ	17	BSR009	50	BSV1201	77
BSD003	113	BSI105	71	BSM240	111	BSM580612D/G	17	BSR011	50	BSV1205	77
BSD010	113	BSI109	111	BSM241	111	BSM580612D/RO	17	BSR012	50	BSV1210	77
BSD011	113	BSI114	74	BSM242	111	BSM580612D/V	17	BSR013	50	BSV1211	77
BSD012	113	BSI220	70	BSM400	83	BSM580712D/AZ	17	BSR014	50	BSV1215	77
BSD013	113	BSI1022	71	BSM402	83	BSM580712D/G	17	BSR017	50	BSV1351	57
BSD013/S	113	BSI1024	71	BSM408	83	BSM580712D/RO	17	BSR018	50	BSV1371	57
BSD300	97	BSI1026	71	BSM410	83	BSM580712D/V	17	BSR019	50	BV057	84
BSD310	97	BSI1027	71	BSM416	83	BSM581001D/B	15	BSR041	50	BV058	84
BSD330	97	BSI1028	71	BSM440	83	BSM581002D/B	17	BSR042	50	BV059	84
BSD335	97	BSI1032	71	BSM441	83	BSM581052D/B	17	BSR048/N	50	BV060	84
BSD525	93	BSI1034	71	BSM470	82	BSO025	86	BSR049/N	50	BV100	113
BSD585	96	BSI1036	71	BSM470/CS	82	BSO026	86	BSR062	50	BV101	113
BSD586	96	BSI1037	71	BSM483	82	BSO027	86	BSR063	50	BV102	113
BSD587	96	BSI1038	71	BSM570	107	BSO028	86	BSR064	50	BV103	113
BSD594	96	BSI4401	70	BSM910/AZ	29	BSO029	86	BSR066	50	BV104	113
BSD598	96	BSL274	73	BSM910/BI	29	BSO030	86	BSR067	50	BVS100	67
BSD599	96	BSL276	73	BSM910/G	29	BSO032	86	BSR075	50	BVS101	67
BSD600	96	BSL277	73	BSM910/RA	29	BSO036	86	BSR076	50	BVS102	67
BSD613	96	BSL278	73	BSM910/RO	29	BSO037	86	BSR080	50	BVS171	67
BSD632	96	BSL483	100	BSM910/V	29	BSO038	86	BSR0625	50	BVS172	68
BSD680	93	BSL486	100	BSM2120	78	BSO039	86	BSR0665	50	BVS174	68
BSD700	94	BSL489	100	BSM5810/AZ	23	BSO040	86	BSS130	113	BVS190	67
BSD701	94	BSL671	73	BSM5810/RO	23	BSO041	86	BSS131	113	BVS1715	67
BSD702	94	BSL672	73	BSM5810/V	23	BSO043	86	BSS133 /A	113	BVS1717	67
BSD703	94	BSL673	73	BSM5827/AZ	35	BSO100	86	BSS134	113	BVS1719	67
BSD704	94	BSL920	73	BSM5827/RO	35	BSO100/BLU	86	BSS135	113	BVS1720	67
BSD706	94	BSL921	73	BSM5827/V	35	BSO100/GR	86	BSS136	113	BVS1721	67
BSD707	94	BSL922	73	BSM58025B1D/AZ	15	BSO100/RO	86	BSS137	113	BVS1741	69
BSD708	94	BSL923	73	BSM58025B1D/G	15	BSO100/V	86	BSS140	113	CL1ARBEPSTS	13
BSD709	94	BSL924	73	BSM58025B1D/RO	15	BSO113	86	BSS141	113	CL1ARBEPSTS/B	13
BSD711	95	BSL925	73	BSM58025B1D/V	15	BSP048	85	BSS230R	113	CL1ARBIPSTS	12
BSD712	96	BSM001	79	BSM58025B/AZ	14	BSP049	85	BSS231R	113	CL1ARBIPSTS/B	12
BSD714	95	BSM001/M	79	BSM58025B/G	14	BSP054	85	BSS232R	113	CL2ARBEP2D	16
BSD715	96	BSM003	79	BSM58025B/RO	14	BSP055	85	BSS233R	113	CL2ARBEP2D/B	16
BSD716	95	BSM003/M	79	BSM58025B/V	14	BSP056	85	BSS234R	113	CL2ARBEPSTS	13
BSD730	94	BSM004	79	BSM58048	19	BSP058	85	BSS235R	113	CL2ARBEPSTS/B	13
BSD749SG	97	BSM004/M	79	BSM58048H	18	BSP059	85	BSS236R	113	CL2ARBIP2D	16
BSD770	95	BSM008	111	BSM58048HE	18	BSP060	85	BSS237R	113	CL2ARBIP2D/B	16
BSD778	95	BSM009	111	BSM58048HI	18	BSP061	85	BSS238R	113	CL2ARBIPSTS	12
BSD855/E	97	BSM011	79	BSM58048L	18	BSP062	85	BSS250	113	CL2ARBIPSTS/B	12
BSD920	96	BSM016	111	BSM58048LE	18	BSP063	85	BSS251	113	CL2AREPSTS	13
BSD930	94	BSM018	111	BSM58048LI	18	BSP066	85	BSS252	113	CL2AREPSTS/B	13
BSD932	94	BSM030	79	BSM58061B1D/AZ	15	BSP068	85	BSS700	112	CL2ARIPSTS	12
BSD934	94	BSM031	79	BSM58061B1D/G	15	BSP069	85	BST128	91	CL2ARIPSTS/B	12
BSD935	94	BSM032	79	BSM58061B1D/RO	15	BSP072	85	BSTA18	84	CL3ARBEPSTS	13
BSD936	94	BSM032/M	79	BSM58061B1D/V	15	BSP073	85	BSTA21	84	CL3ARBEPSTS/B	13
BSD5250	93	BSM080	80	BSM58061B/AZ	14	BSP074	85	BSTA23	84	CL4ARBEPSTS	13
BSD7101	94	BSM081	80	BSM58061B/G	14	BSP075	85	BSTA33	84	CL4ARBEPSTS/B	13
BSF2051	84	BSM082	80	BSM58061B/RO	14	BSP076	85	BSV011	91	CL4ARBIPSTS	12
BSF2051/CS	84	BSM083	80	BSM58061B/V	14	BSP077	85	BSV012	91	CL4ARBIPSTS/B	12

# Cat.No. Index

REF.	Pag.	REF.	Pag.	REF.	Pag.
CL4ARIPSTS	12	CL616/S	29	VBS656/AZ	72
CL4ARIPSTS/B	12	CL720	29	VBS656/B	72
CL05.001.0500	30	CL724/S	29	VBS656/G	72
CL05.005.0100S	30	CL726/S	29	VBS656/RA	72
CL05.010.1000B	30	CL730	29	VBS656/V	72
CL05.020.0500B	30	CL734/S	29	VBS5001	72
CL05.050.0001S	30	CL736/S	29	VBS6502	72
CL5ARBEP2D	16	CL740	29	VBS6512	72
CL5ARBEP2D/B	16	CL744/S	29	ZTD-SPLS-FLT	22
CL5ARBEPSTS	13	CL746/S	29	ZTD-SPLS-FLT1	22
CL5ARBEPSTS/B	13	CL750	29	ZTS-1DR2-A4-BRK	21
CL5ARBIPS2D	16	CL754/AM*	29		
CL5ARBIPS2D/B	16	CL754/S	29		
CL5ARBIPSTS	12	CL754/SAM	29		
CL5ARBIPSTS/B	12	CL756/S	29		
CL5ARIPSTS	12	CL810	29		
CL5ARIPSTS/B	12	CL810/AZ	29		
CL15.002.0500	30	CL810/BI	29		
CL15.004.0050S	30	CL810/G	29		
CL15.010.1000B	30	CL810/RA	29		
CL15.020.0500B	30	CL810/RO	29		
CL15.100.0001S	30	CL810/V	29		
CL20.002.0500	30	CL811	29		
CL20.004.0050S	30	CL811/AZ	29		
CL20.008.1000B	30	CL811/BI	29		
CL20.016.0500B	30	CL811/G	29		
CL20.100.0001S	30	CL811/RA	29		
CL022	34	CL811/RO	29		
CL022/AM	34	CL811/V	29		
CL026	34	CL812	29		
CL026/AM	34	CL812/AZ	29		
CL50.002.0100	31	CL812/BI	29		
CL50.006.0500B	31	CL812/G	29		
CL50.010.0020S	31	CL812/RA	29		
CL50.030.0100B	31	CL812/RO	29		
CL50.050.0001S	31	CL812/V	29		
CL100	47	CRY910TS/AZ	23		
CL101	47	CRY910TS/BI	23		
CL102	47	CRY910TS/G	23		
CL103	47	CRY910TS/RO	23		
CL105	47	CRY910TS/V	23		
CL106	47	CRY910TS/VI	23		
CL107	47	CRY920TS	23		
CL108	47	SG20BHP-USB002	21		
CL109	47	SG20THP-USB001	21		
CL111	47	VBS626	75		
CL112	47	VBS627	75		
CL113	47	VBS628	75		
CL0269	34	VBS629	75		
CL0269/AM	34	VBS630	75		
CL474	37	VBS633	72		
CL474	83	VBS634	72		
CL475	37	VBS636	72		
CL475	83	VBS637	72		
CL477	37	VBS638	72		
CL477	83	VBS649	72		
CL482	37	VBS650	72		
CL482	83	VBS651	72		
CL490	37	VBS653	72		
CL490	83	VBS653/A	72		
CL600	29	VBS654	72		
CL604/S	29	VBS654/A	72		
CL606/S	29	VBS655	72		
CL610	29	VBS655/A	72		
CL614/S	29	VBS656	72		
		VBS656/AR	72		

Biosigma: Biotechnology and Clinical Chemistry products

© Copyright 2019 Biosigma S.r.l.

Produced by Biosigma S.r.l.

All rights are reserved.  
No part of this publication may be reproduced in any form without prior permission from Biosigma S.r.l.

The products depicted in this catalogue are true to specification at the moment of publication.  
Biosigma S.r.l. reserves the right to any given changes as to materials or finishes without advance notification.

**The presentation and materials shown provide only a point of reference (photos are not contractual).**

**CLEARLine®**  
"Be cool, be safe, be CLEARLine"



a Dominique Dutscher company

Address: Via Valletta, 6 • 30010, Cona (Venice) Italy

Phone ++39 0426 302226

Fax ++39 0426 302228

[export@biosigmaeu.com](mailto:export@biosigmaeu.com)

[www.biosigma.com](http://www.biosigma.com)

V.A.T. IT 03228440270

Ver. 2019-10

**CLEARLine**<sup>®</sup>  
"Be cool, be safe, be CLEARLine"